



# AIROUTIL

FABRICATION FRANCAISE



ASSISTANCE  
MATÉRIEL  
OUTILLAGE

# AIROUTIL

L'OUTILLAGE DES PROFESSIONNELS

TARIF JANVIER 2016

# sommaire

DESIGNATIONS	PAGES
Accessoires pour machines pneumatiques .....	32
Accessoires pour Mig .....	38
Brosseuse et consommables .....	13
Burineur .....	20
Clés à chocs et consommables .....	22 à 29
Clés à cliquet .....	22
Coffret de rénovation d'optique de phare .....	11
Coffret de réparation des pattes en plastique .....	37
Consommables de soudage et pointeuses .....	36
Coupes gomme et consommables .....	4
Crayon à graver .....	21
Débosseleur AIR PULLER et consommables .....	34
Débosseleur par collage et consommables .....	36
Décapeur .....	20
Disqueuses 125/180mm et consommables .....	18
Douilles à chocs .....	23 à 29
Douilles pour transmission .....	24
Douilles à contrôle de couple .....	24
Douilles à bougie et accessoires .....	43
Douilles à main et accessoires .....	44/45
Eléments de filtration d'air .....	31
Enrouleurs de tuyau d'air .....	31
Génératrice d'air chaud .....	40
Gonfleur .....	30
Grattoir .....	20
Grignoteuse .....	21
Lustreuses 75/150/180mm et consommables .....	11/12
Manchettes coaxiales d'aspiration .....	9
Marchepieds .....	40
Matériels d'entretien de véhicule .....	47
Matériels pour atelier carrosserie/peinture .....	39/40
Meuleuse d'angle 125mm et consommables .....	19
Meuleuses et consommables .....	14/15
Meuleuse pour cordon de soudure laser .....	13
Outils divers carrosserie .....	39 à 41
Outils à main de carrosserie .....	42
Outils atelier mécanique .....	47
Perceuses et consommables .....	16/17
Pièces détachées pour matériels AIROUTIL .....	9
Pincés à déborder .....	13
Pincés de tirage .....	41
Pistolets à cartouche .....	30
Pistolets à souder et consommables .....	35
Pistolet pulvérisateur .....	30
Pistolet insonorisant et corps creux .....	30
Pistolet de sablage .....	30
Ponceuse du peintre PV96 et consommables .....	8
Ponceuses orbitales 150mm et consommables .....	6/7
Ponceuses 75mm et consommables .....	11
Ponceuses à bande et consommables .....	10
Ponceuse Spot Repair 32mm .....	11
Raccords et coupleurs .....	32
Riveteuses et consommables .....	21
Scies alternatives et consommables .....	5
Sertisseuse de panneaux de porte .....	13
Servante d'aspiration .....	9
Soudeurs des plastiques et consommables .....	37
Soufflettes .....	30
Spotters et consommables .....	35
Supports d'éléments à peindre .....	39
Surfaceurs 150mm et consommables .....	6/7
Surfaceurs 200mm et consommables .....	8
Tête à dépointer et consommables .....	16
Tréteaux .....	39
Tronçonneuses et consommables .....	14/15
Tuyaux d'air .....	31/32
Ventouses .....	37
Données techniques des machines .....	48/49

**POUR L'ATELIER S.A.V.**

**OUTILLAGE  
PNEUMATIQUE**

**TOUTES MARQUES**

**NOUS CONSULTER**

# DEPOSES PARE BRISE



**AICG187** Coupe gomme intensif **AIROUTIL** 523,95 €

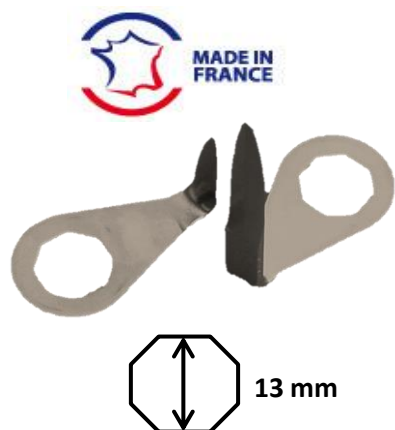

Lames pour AICG187 <b>AIROUTIL</b>			
AICG16	Lame 16mm	*	21,10 €
AICG18	Lame 18mm	*	21,10 €
AICG22	Lame 22mm	*	21,10 €
AICG25	Lame 25mm	*	21,10 €
AICG30	Lame 30mm	*	21,10 €
AICG40	Lame 40mm	*	21,10 €
AICG50	Lame 50mm	*	21,10 €
AICG50M	Lame 28mm (spéciale MERCEDES)	*	21,10 €
AICG60	Lame 60mm	*	21,10 €
AICG90	Lame 90mm	*	22,35 €
AICG130	Lame 130mm	*	26,75 €
AICGP	Lame pelle de nettoyage	*	16,40 €
AICG87030	Garde caoutchouc		11,85 €

\* voir grille remises quantitatives



**AICG6** Coupe gomme standard 362,25 €

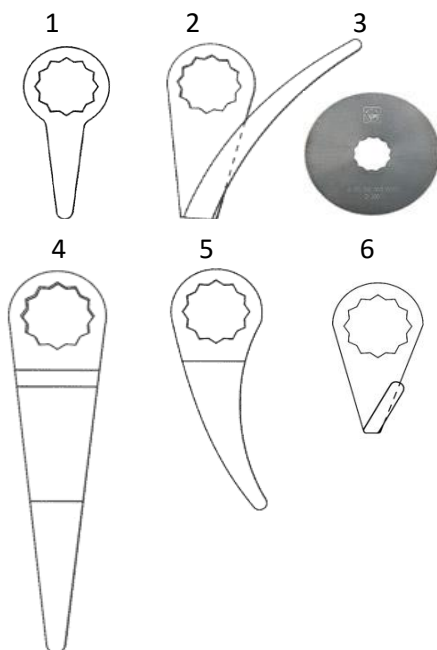

Lames coupe gomme standard			
AICG620	Lame droite 35mm	1	19,20 €
AICG621	Lame droite 57mm	1	20,80 €
AICG622	Lame droite 90mm	4	31,80 €
AICG634	Lame droite 120mm	4	64,90 €
AICG623	Lame courbe 30mm	5	26,45 €
AICG624	Lame en U 20mm	6	35,50 €
AICG625	Lame en U 24mm	6	35,50 €
AICG626	Lame en U 36mm	6	40,00 €
AICG619	Lame en U 40mm	2	62,90 €
AICG627	Lame en U 63mm	2	45,90 €
AICG628	Lame en U 90mm	2	65,10 €
AICG631	Lame de décapage de baie de P.B.		45,15 €
AICG632	Lame circulaire 75mm pour tole	3	40,10 €
AICG633	Lame circulaire 63mm pour tole	3	38,85 €

## SCIES ALTERNATIVES



**AIROUTIL**



**AISA186** Scie alternative intensive **AIROUTIL** 391,65 €



Lames et accessoires pour AISA186		<b>AIROUTIL</b>	
AISA8032	10 lames 12 dts/cm	*	42,95 €
AISA8024	10 lames 10 dts/cm	*	42,95 €
AISA8022	10 lames 8 dts/cm	*	42,95 €
AISA8132	10 lames fines 12 dts/cm	*	42,95 €
AISA8124	10 lames fines 10 dts/cm	*	42,95 €
AISA8040	Lame diamantée	*	64,45 €
AISA8052	Porte lame		15,00 €
AISA86010	Patin de guidage		15,55 €
AISA86007	Butée de profondeur		14,70 €

\* voir grille remises quantitatives



**AISA1** Scie alternative standard 204,75 €



Lames pour scie alternative standard AISA1			
AISA102	5 lames 6 dents/cm	*	25,95 €
AISA103	5 lames 10 dents/cm	*	25,95 €
AISA104	5 lames 12 dents/cm	*	25,95 €
AISA113	5 lames fines 10 dents/cm	*	27,60 €
AISA114	5 lames fines 12 dents/cm	*	27,60 €

\* voir grille remises quantitatives

## LAMES DE SCIE TYPE SIG / WIELANDER



AI197000	10 lames 8 dents/cm	*	46,20 €
AI197002	10 lames 10 dents/cm	*	46,20 €
AI197003	10 lames 12 dents/cm	*	46,20 €



AI197001	10 lames courtes 9 dents/cm	*	46,20 €
----------	-----------------------------	---	---------



AI197010	Lame diamantée	*	71,10 €
----------	----------------	---	---------

\* voir grille remises quantitatives

## PONCEUSES 150mm



ASSISTANCE  
MATERIEL  
OUTILLAGE

**AIROUTIL**<sup>®</sup>



AIROUTIL

**AIPA97** Ponceuse orbitale 150mm/5mm **supprimé**

**AIPA975** Ponceuse AIPA97 avec manchette 5m **supprimé**

**AIP10150VT** Plateau 150 mm velcro 6 trous \* **28,85 €**

**AIP150V15** Plateau 150 mm velcro 15 trous \* **supprimé**



**AIPE1A** Ponceuse orbitale 1 main 150mm/5mm **236,25 €**

**AIPE1A5** Ponceuse AIPE1A avec manchette 5m **338,10 €**

**AIP10150VT** Plateau 150 mm velcro 6 trous \* **28,85 €**

**AIP150V15** Plateau 150 mm velcro 15 trous \* **37,70 €**



**AIPE3CA** Ponceuse orbitale 2 mains 150mm/5mm **361,70 €**

**AIPE3CA5** Ponceuse AIPE3CA avec manchette 5m **463,55 €**

**AIP10150VT** Plateau 150 mm velcro 6 trous \* **28,85 €**

**AIP150V15** Plateau 150 mm velcro 15 trous \* **37,70 €**



**AIPO12** Ponceuse orbitale 2 mains 150mm/6mm **340,20 €**

**AIP150V** Plateau velcro 150 mm \* **34,65 €**

## SURFACEURS 150mm



**AISU150** Surfaceur 1 main 150mm standard **348,40 €**

**AISU1505** Surfaceur 1 main 150mm standard avec manchette coaxiale 5m **450,25 €**

**AISUP150VE** Plateau 150 mm velcro 6 trous \* **63,30 €**



**AISU150A** Surfaceur 2 mains 150mm intensif **608,15 €**

**AISU1505A** Surfaceur 2 mains 150mm intensif avec manchette coaxiale 5m **710,00 €**

**AISUP150VA** Plateau 150 mm velcro 15 trous **102,35 €**

\* voir grille remises quantitatives



## PLATEAUX VELCRO 75 MM



**AIR OUIL**

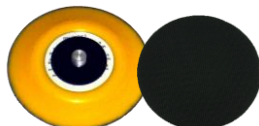

AIPO78007	Plateau Velcro 75 mm 5/16"	*	25,95 €
AIP75M6	Plateau Velcro 75 mm M6		31,90 €

## PLATEAUX VELCRO 150 MM



AIP150V	Plateau velcro 150 mm	*	34,65 €
---------	-----------------------	---	---------

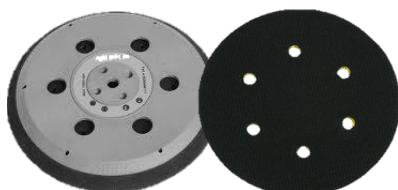

AIP10150VT	Plateau velcro 6 trous 150mm	*	28,85 €
AIP150SOFT	Plateau velcro 15 trous 150mm souple	*	57,20 €

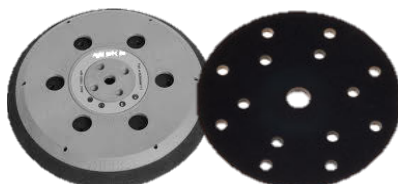

AIP150V15	Plateau velcro 15 trous 150mm	*	37,70 €
AIP150V75	Plateau velcro 75 trous 150mm	*	39,60 €



<b>PLATEAU pour SURFACEUR AISU150</b>			
AISUP150VE	Plateau velcro 6tr 150mm	*	63,30 €

<b>PLATEAU pour SURFACEUR AISU150A</b>			
AISUP150VA	Plateau velcro 15tr 150mm		102,35 €

<b>PLATEAU POUR SURFACEUR AISU15</b>			
AISUP150V15	Plateau velcro médium 15tr 150mm	*	58,40 €



\* voir grille remises quantitatives

## DISQUES ABRASIFS VELCRO 15TR 150mm

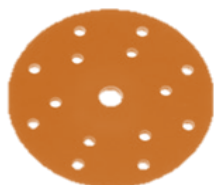

AID150060	Bte 50 disques GOLD 15tr P60		20,15 €
AID150080	Bte 100 disques GOLD 15tr P80		38,85 €
AID150120	Bte 100 disques GOLD 15tr P120		37,15 €
AIDF150150	Bte 100 disques GOLD 15tr P150		37,15 €
AID150180	Bte 100 disques GOLD 15tr P180		37,15 €
AID150240	Bte 100 disques GOLD 15tr P240		37,15 €
AID150320	Bte 100 disques GOLD 15tr P320		37,15 €
AID150400	Bte 100 disques GOLD 15tr P400		37,15 €
AID150500	Bte 100 disques GOLD 15tr P500		37,15 €
AIDIM150	Interface mousse 6tr auto-agrippante		14,50 €

## PONCEUSE DU PEINTRE



**AIROUTIL**



AIROUTIL



<b>AIPV96</b>	Ponceuse du peintre	<b>AIROUTIL</b>	391,65 €
---------------	---------------------	-----------------	----------

<b>AIPV965</b>	Ponceuse avec manchette 5m		494,55 €
----------------	----------------------------	--	----------

<b>AIPV96030</b>	Plateau 6 trous auto-agrippant	*	41,60 €
------------------	--------------------------------	---	---------

### Coupes abrasives pour AIPV96

<b>AIPV96060</b>	Bte 50 abrasifs papier P60	*	35,05 €
<b>AIPV96080</b>	Bte 50 abrasifs papier P80	*	32,45 €
<b>AIPV96120</b>	Bte 50 abrasifs papier P120	*	29,90 €
<b>AIPV96180</b>	Bte 50 abrasifs papier P180	*	29,90 €
<b>AIPV96240</b>	Bte 50 abrasifs papier P240	*	29,90 €
<b>AIPV96320</b>	Bte 50 abrasifs papier P320	*	29,90 €
<b>AIPV96400</b>	Bte 50 abrasifs papier P400	*	29,90 €
<b>AIPV96FIN</b>	Bte 30 abrasifs mousse P500	*	32,25 €
<b>AIPV96SUF</b>	Bte 30 abrasifs mousse P800	*	35,50 €
<b>AIPV96MIFA</b>	Bte 10 abrasifs ABRALON P1000	*	30,60 €
<b>AIPV96MIRA</b>	Bte 10 abrasifs ABRALON P2000	*	30,60 €

## SURFACEURS 200mm



<b>AISU203E</b>	Surfaceur 2 mains 200mm STANDARD		380,50 €
-----------------	----------------------------------	--	----------

<b>AISU2035E</b>	Surfaceur AISU203E + manchette 5m		482,35 €
------------------	-----------------------------------	--	----------

<b>AIP203VE</b>	Plateau velcro 8 trous 200mm	*	87,90 €
-----------------	------------------------------	---	---------



<b>AISU203A</b>	Surfaceur 2 mains 200mm INTENSIF		661,50 €
-----------------	----------------------------------	--	----------

<b>AISU2035A</b>	Surfaceur 2 mains 200mm INTENSIF avec manchette coaxiale 5m		760,20 €
------------------	---	--	----------

<b>AIP203VA</b>	Plateau velcro 8 trous 200mm		105,50 €
-----------------	------------------------------	--	----------

PLATEAU POUR SURFACEUR AISU93		<b>AIROUTIL</b>	
<b>AIP203V</b>	Plateau velcro 8 trous 200mm	*	86,30 €

\* voir grille remises quantitatives

### DISQUES ABRASIFS 200mm



<b>AISU203040</b>	Bte 50 disques GOLD 8 trous P40		43,90 €
<b>AISU203060</b>	Bte 50 disques GOLD 8 trous P60		39,60 €
<b>AISU203080</b>	Bte 100 disques GOLD 8 trous P80		78,20 €
<b>AISU203120</b>	Bte 100 disques GOLD 8 trous P120		72,85 €
<b>AISU203180</b>	Bte 100 disques GOLD 8 trous P180		72,85 €
<b>AISU203240</b>	Bte 100 disques GOLD 8 trous P240		72,85 €
<b>AISU203320</b>	Bte 100 disques GOLD 8 trous P320		72,85 €

## SERVANTE ASPIRANTE



**AIROUTIL**



<b>AIS1300C</b>	Servante aspirante 1300W Cuve inox 30L Dépression 2200 KPa Débit d'air 180 m3/H Poids à vide 10 Kgs Avec démarrage automatique et filtre auto-décolmatant Equipée d'une gaine coaxiale de 5m	<b>1 011,15 €</b>
-----------------	--	-------------------

<b>AIS1300C+</b>	Servante aspirante 1300W complète Avec démarrage automatique et filtre auto-décolmatant Equipée d'une gaine coaxiale de 5m + une ponceuse <b>AIFE1A</b>	<b>1 222,20 €</b>
------------------	--	-------------------



## GAINE D'ASPIRATION

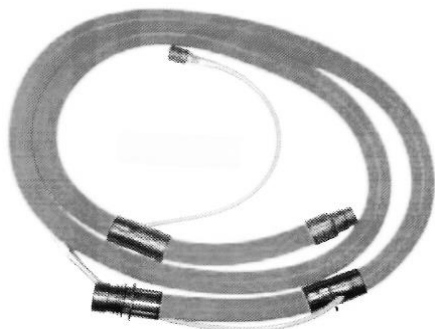

<b>AIMPV965</b>	Manchette coaxiale standard 5m	<b>122,30 €</b>
-----------------	--------------------------------	-----------------

Possibilité de manchette sur mesure, nous consulter

<b>Manchette pour ponceuse PA50 / PA80 / SU15 / SU93</b>		<b>AIROUTIL</b>
<b>AIPA89MC4</b>	Manchette coaxiale 4m	<b>132,30 €</b>
<b>AIPA89MC6</b>	Manchette coaxiale 6m	<b>163,60 €</b>

<b>Tuyau d'aspiration au mètre</b>		
<b>AITA25</b>	1m tuyau d'aspiration 25mm int.	12,05 €
<b>AITA28</b>	1m tuyau d'aspiration 28mm int.	12,60 €
<b>AITA32</b>	1m tuyau d'aspiration 32mm int.	13,10 €

## PIECES DETACHEES ET ACCESSOIRES DE MATERIELS

**AIROUTIL**

<b>AI3239</b>	Filtre conique pour S1200	101,85 €
<b>AI3240</b>	Filtre conique pour SERVANTE 25 et SERVANTE 16	144,25 €
<b>AIBB35</b>	Moteur turbine pour SERVANTE 16/25 et S1200, TURB95 et S2000	197,40 €
<b>AICA2000018</b>	Filtre pour SERVANTE 2000 et TURB95	69,80 €
<b>AICA2111</b>	Filtre pour TURB92	139,10 €
<b>AIDP88017</b>	Pince épaulée 8mm pour dépointeur DP88	41,80 €
<b>AIMD20008</b>	Pince 6mm pour MD20 / MD120 / XE65	41,80 €
<b>AIMD20083</b>	Pince 3mm pour MD20 / MD120	41,80 €
<b>AISA3504</b>	Filtre auto-décolmatant pour SERVANTE 16/25 et S1200	120,55 €



## PONCEUSES A BANDE



**AIROUTIL**



**AIPB573** Ponceuse à bandes 10x330mm 201,60 €

**AIPB52** Ponceuse à bandes 20x520mm 448,55 €

## BANDES A PONCER AU ZIRCONIUM

15 X 330

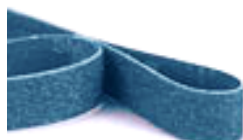

10 X 330

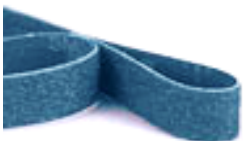

20 X 520

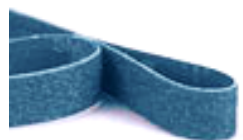

Bandes 15 x 330 mm pour AIPB330 / AIPB33			AIROUTIL
AIPB3336	10 bandes abrasives 15x330mm P36	*	21,95 €
AIPB3350	10 bandes abrasives 15x330mm P50	*	21,40 €
AIPB3360	10 bandes abrasives 15x330mm P60	*	21,40 €
AIPB3380	10 bandes abrasives 15x330mm P80	*	21,40 €
AIPB33120	10 bandes abrasives 15x330mm P120	*	21,40 €

Bandes 10 x 330 mm pour AIPB573			
AIPB3536	10 bandes abrasives 10x330mm P36	*	14,75 €
AIPB3550	10 bandes abrasives 10x330mm P50	*	11,95 €
AIPB3560	10 bandes abrasives 10x330mm P60	*	11,95 €
AIPB3580	10 bandes abrasives 10x330mm P80	*	11,95 €
AIPB35120	10 bandes abrasives 10x330mm P120	*	11,95 €

Bandes 20 x 520 mm pour AIPB52			
AIPB52036	10 bandes abrasives 20x520mm P36	*	18,70 €
AIPB52050	10 bandes abrasives 20x520mm P50	*	15,85 €
AIPB52060	10 bandes abrasives 20x520mm P60	*	15,85 €
AIPB52080	10 bandes abrasives 20x520mm P80	*	15,85 €
AIPB52120	10 bandes abrasives 20x520mm P120	*	15,85 €

\* voir grille remises quantitatives

## PONCEUSES 75mm



**AIPB5C** Ponceuse orbitale 1 main 75mm/2,5mm 308,30 €

AIPO78007 Plateau velcro 75mm \* 25,95 €

**AIPO75** Ponceuse orbitale revolver 75mm/2,5mm 153,40 €

AIPO78007 Plateau velcro 75mm \* 25,95 €



DISQUES ABRASIFS 77mm		
AID750080	Bte 100 disques P80	51,55 €
AID750120	Bte 100 disques P120	51,55 €
AID750180	Bte 100 disques P180	51,55 €
AID750240	Bte 100 disques P240	51,55 €
AID750320	Bte 100 disques P320	51,55 €
AID750400	Bte 100 disques P400	51,55 €
AID750500	Bte 100 disques P500	51,55 €
AID750600	Bte 50 disques P600	27,00 €
AID750800	Bte 50 disques P800	27,00 €
AID751000	Bte 50 disques P1000	27,00 €
AID751200	Bte 50 disques P1200	27,00 €
AID751500	Bte 50 disques P1500	27,00 €
AIDIM75	Interface mousse 77mm	10,10 €

## COFFRET DE RENOVATION D'OPTIQUE DE PHARE



<b>AICROP</b>	<b>Coffret de rénovation d'optique de phare</b> comprenant : 1 mini ponceuse <b>AIPO75</b> 1 mini lustreuse <b>AILR75</b> , 20 disques abrasifs P320, P400, P500, 1 interface mousse, 20 disques ABRALON P1000, P2000, P4000 2 mousses de polissage, 2 mousses de lustrage 1 bidon de rénovateur, 1 bidon de polish, 1 chiffon microfibre	<b>561,75 €</b>
---------------	--	-----------------



Disques ABRALON 77mm		
<b>AID75M0500</b>	Bte 20 disques P500	34,65 €
<b>AID75M1000</b>	Bte 20 disques P1000	34,65 €
<b>AID75M2000</b>	Bte 20 disques P2000	34,65 €
<b>AID75M3000</b>	Bte 20 disques P3000	34,65 €
<b>AID75M4000</b>	Bte 20 disques P4000	34,65 €

## SPOT REPAIR 32 mm



<b>AIPO32C</b>	<b>Coffret ponceuse SPOT REPAIR 32mm</b> livré avec assortiment de 48 disques abrasifs <b>ABRALON</b> (1000, 2000, 4000) et <b>TRIZACT</b> P3000	<b>192,65 €</b>
----------------	---	-----------------

<b>AIKP32</b>	<b>Kit de ponçage 32 mm comprenant :</b> 1 plateau de 32 mm et un assortiment de 48 disques abrasifs <b>ABRALON</b> (1000, 2000, 4000) et <b>TRIZACT</b> P3000	<b>59,45 €</b>
---------------	---	----------------

<b>AIP32</b>	Plateau velcro 32 mm	30,25 €
<b>AID32M1000</b>	Sachet 12 disques ABRALON P1000	7,35 €
<b>AID32M2000</b>	Sachet 12 disques ABRALON P2000	7,35 €
<b>AID32M4000</b>	Sachet 12 disques ABRALON P4000	7,35 €
<b>AID32T3000</b>	Sachet 12 disques TRIZACT P3000	13,55 €

## LUSTREUSE 75mm



<b>AILR75</b>	<b>Mini lustreuse révolver 75mm</b>	<b>158,85 €</b>
---------------	-------------------------------------	-----------------

<b>AIPO78007</b>	Plateau velcro 75mm	*	<b>25,95 €</b>
------------------	---------------------	---	----------------

\* voir grille remises quantitatives



Accessoires de polissage/lustrage velcro 77mm		
<b>AIMPM</b>	Lot de 5 peaux de mouton naturelles	37,80 €
<b>AIMPOR</b>	Lot de 2 mousses rigides	19,40 €
<b>AIMPOS</b>	Lot de 2 mousses semi rigides	21,20 €
<b>AIMLNS</b>	Lot de 2 mousses souples	17,30 €

## LUSTREUSES 150 / 180mm



**AIROUTIL**



<b>AILV18C</b>	Lustreuse verticale 75 / 150mm livrée avec ses 2 plateaux 5/16"	399,50 €
----------------	--	----------

AIPO78007	Plateau velcro 75mm 5/16"	*	25,95 €
AIP150V	Plateau velcro 150mm 5/16"	*	34,65 €



<b>AILR50C</b>	Lustreuse d'angle 180mm livrée avec disque et peau de mouton	304,50 €
----------------	---	----------



<b>AILV51C</b>	Lustreuse verticale 180mm livrée avec disque et peau de mouton	234,45 €
----------------	---	----------

## PLATEAUX ET ACCESSOIRES POUR LUSTREUSES



<b>AIDR2055</b>	Plateau nylon 180mm femelle 5/8"	16,05 €
-----------------	----------------------------------	---------

### PLATEAU VELCRO FEMELLE 5/8"

<b>AIPL125V</b>	Plateau semi-souple velcro 125mm	31,90 €
<b>AIPL150V</b>	Plateau semi-souple velcro 150mm	33,90 €
<b>AIL580</b>	Plateau semi-souple velcro 180mm	40,10 €



### PLATEAU VELCRO FEMELLE M14 (ELECTRIQUE)

<b>AIPL125V14</b>	Plateau semi-souple velcro 125mm	31,90 €
<b>AIPLS150V14</b>	Plateau souple velcro 150mm	33,60 €



<b>AIMPT150</b>	Mousse lustrage souple velcro 150mm	22,25 €
<b>AIMPT200</b>	Mousse lustrage souple velcro 200mm	29,70 €

<b>AIMPD150</b>	Mousse polissage dure velcro 150mm	18,25 €
<b>AIMPD200</b>	Mousse polissage dure velcro 200mm	29,70 €



<b>AIPMV125</b>	Peau de mouton velcro 125mm	13,00 €
<b>AIPMV150</b>	Peau de mouton velcro 150mm	14,15 €
<b>AIPMV180</b>	Peau de mouton velcro 180mm	21,20 €
<b>AIPM200</b>	Peau de mouton à lacet 200mm	17,30 €

## BROSSEUSE



**AIBT3C** Brosseuse livrée avec 1 brosse 23mm **408,75 €**

**AIBT363** Support 1 roue de décapage **27,30 €**

**AIBT364** Support 2 roues de décapage **27,30 €**

**AIBT373** Roue à décaper 100x13x13mm **11,35 €**

**AIBT361** Support brosse et roue gomme 23mm **27,30 €**

**AIBT362** Support brosse 11mm **27,30 €**

**AIBT367** Brosse droite 23mm **24,55 €**

**AIBT369** Brosse droite 11mm **24,55 €**

**AIBT368** Brosse crochet 23mm **24,55 €**

**AIBT370** Brosse crochet 11mm **24,55 €**

**AIBT371** Roue gomme standard 30x105mm **32,55 €**

**AIBT372** Roue gomme tendre 30x105mm **32,55 €**

## SERTISSEUSE DE PANNEAUX DE PORTES ET BORDURES D'AILES



**AISPPBA** Sertisseuse avec 2 supports 6 tampons **656,35 €**

**AIPP1** Pince à déborder tôle ACIER PM **40,55 €**

**AIPP2** Pince à déborder tôle ACIER GM **43,70 €**

## MEULEUSE POUR CORDON DE SOUDURE LASER



**AIFL50** Coffret fraiseuse pour cordon de soudure **397,10 €**

### ACCESSOIRES

**AI640005** Axe porte fraise profondeur 0,8mm **43,70 €**

**AI640010** Axe porte fraise profondeur 1mm **43,70 €**

**AI640025** Fraise carbure 25 x 4mm **128,40 €**

**AIHC** Flacon 200ml huile de coupe **15,35 €**





# MEULEUSES ET TRONCONNEUSES



<b>AIM22</b>	Meuleuse droite Pince 6 mm 22 000 tr/min	73,30 €
--------------	---	---------



<b>AIM22C</b>	Meuleuse droite gainée Pince 6 mm 22 000 tr/min	124,10 €
---------------	--	----------



<b>AIM45</b>	Meuleuse basse vitesse Pince 6 mm 4 500 tr/min	154,15 €
--------------	---	----------



<b>AIM45V</b>	Meuleuse vulcanisatrice 4 500 tr/min Mandrin hexagonal 7/16"	168,20 €
---------------	---	----------



<b>AIM9</b>	Meuleuse d'angle Pince 6 mm 22 000 tr/min	142,80 €
-------------	--	----------



<b>AIM9C</b>	Meuleuse d'angle gainée Pince 6 mm 22 000 tr/min	166,85 €
--------------	---	----------



<b>AIDR491</b>	Meuleuse d'angle 22 000 tr/m type ROLOC	124,10 €
----------------	--	----------



<b>AI39529</b>	Tronçonneuse gainée 18 000 tr/min	112,35 €
----------------	-----------------------------------	----------



ACCESSOIRES MEULEUSES ET TRONCONNEUSES		
<b>AIMDE23B23</b>	Pince de 6 mm	17,85 €
<b>AIMDE23BP3</b>	Pince de 3 mm	17,85 €
<b>AIMDE23B25</b>	Ecrou de pince	9,05 €
<b>AIGS11</b>	Gaine échappement pour meuleuse d'angle	31,80 €
<b>AIGS12</b>	Gaine échappement pour meuleuse	31,80 €

**CONSOMMABLES DIAM. 6mm  
pour MEULEUSES 22000 tr/min**



**AIROUTIL®**



<b>AIMD20016</b>	Axe 6mm spécial meule plates 76mm	*	<b>11,15 €</b>
------------------	-----------------------------------	---	----------------

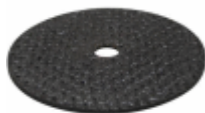

<b>MEULES PLATES 76mm</b>		
<b>AIDT7610</b>	Bte 50 meules plates 76x1x10mm	<b>87,55 €</b>
<b>AIDT7616</b>	Bte 50 meules plates 76x1.6x10mm	<b>87,55 €</b>
<b>AIDT7648</b>	Bte 10 meules plates 76x4,8x10mm	<b>35,60 €</b>



<b>AIDRA2225</b>	Plateau 50mm type ROLOC sur axe 6 mm	*	<b>13,65 €</b>
<b>AIDRA2227</b>	Plateau 75mm type ROLOC sur axe 6 mm	*	<b>16,40 €</b>

\* voir grille remises quantitatives

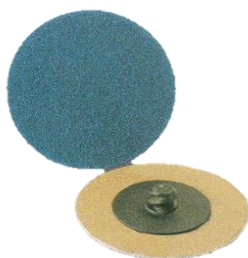

<b>Disques type ROLOC 50 et 75mm Zirconium</b>		
<b>AIDR50036</b>	Bte 100 disques 50mm P36	<b>100,70 €</b>
<b>AIDR50060</b>	Bte 100 disques 50mm P60	<b>84,20 €</b>
<b>AIDR50080</b>	Bte 100 disques 50mm P80	<b>80,65 €</b>
<b>AIDR50120</b>	Bte 100 disques 50mm P120	<b>80,65 €</b>
<b>AIDR75036</b>	Bte 50 disques 75mm P36	<b>78,75 €</b>
<b>AIDR75060</b>	Bte 50 disques 75mm P60	<b>61,40 €</b>
<b>AIDR75080</b>	Bte 50 disques 75mm P80	<b>58,25 €</b>
<b>AIDR75120</b>	Bte 50 disques 75mm P120	<b>56,60 €</b>

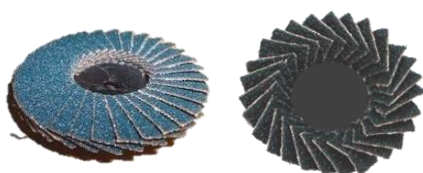

<b>Disques à lamelles type ROLOC 50 et 75mm Zirconium</b>		
<b>AIDR49140</b>	10 disques plats 50mm P40	<b>34,10 €</b>
<b>AIDR49160</b>	10 disques plats 50mm P60	<b>34,10 €</b>
<b>AIDR49180</b>	10 disques plats 50mm P80	<b>34,10 €</b>
<b>AIDR59940</b>	10 disques coniques 50mm P40	<b>39,05 €</b>
<b>AIDR59960</b>	10 disques coniques 50mm P60	<b>39,05 €</b>
<b>AIDR59980</b>	10 disques coniques 50mm P80	<b>39,05 €</b>



<b>Fraises carbure sur tige 6mm</b>		
<b>AIFLCB6</b>	Fraise carbure sphérique 6mm	<b>16,05 €</b>
<b>AIFLCB8</b>	Fraise carbure sphérique 8mm	<b>22,35 €</b>
<b>AIFLCB10</b>	Fraise carbure sphérique 10mm	<b>28,25 €</b>
<b>AIFLCB12</b>	Fraise carbure sphérique 12mm	<b>37,05 €</b>
<b>AIFLCC12</b>	Fraise carbure cylindrique bout rond	<b>38,55 €</b>



<b>Meule corindon sur tige de 6 mm</b>		
<b>AIMT103260</b>	Meule W179 10 x 32 mm Gr.60	<b>2,00 €</b>
<b>AIMT203246</b>	Meule W206 20 x 32 mm Gr.36	<b>2,60 €</b>
<b>AIMT323236</b>	Meule W230 32 x 32 mm Gr.36	<b>3,80 €</b>



<b>Roue à lamelles sur tige de 6 mm</b>		
<b>AIRL301580</b>	10 roues à lamelles Diam. 30 Eps. 15 GR.80	<b>29,20 €</b>

## PERCEUSES



<b>AIMFA10C</b>	Perceuse composite réversible 10mm 2600 tr/min avec mandrin automatique	126,75 €
<b>AIMFA10CA</b>	Idem avec mandrin automatique 10mm <b>acier</b>	146,80 €



<b>AIMF3C</b>	Perceuse revolver réversible 13mm 800 tr/min mandrin acier à clé	283,10 €
<b>AIMF3CA</b>	Idem avec mandrin automatique 13mm <b>acier</b>	317,00 €



<b>AIMF4</b>	Perceuse d'angle réversible 10mm 1200 tr/min mandrin acier à clé	245,60 €
<b>AIMF4A</b>	Idem avec mandrin automatique 10mm <b>acier</b>	279,60 €



<b>AIMF5</b>	Perceuse droite 10mm 4500 tr/min mandrin acier à clé	133,85 €
<b>AIMF5A</b>	Idem avec mandrin automatique 10mm <b>acier</b>	186,70 €

## ACCESSOIRES pour PERCEUSES



<b>AIMF13004</b>	Mandrin plastique auto. 13mm	59,85 €
<b>AIMF13005</b>	Mandrin acier auto. 13mm	73,50 €
<b>AIMF13006</b>	Mandrin acier à clé 13mm	35,15 €
<b>AIMF19004</b>	Mandrin plastique auto. 10mm	34,95 €
<b>AIMF19005</b>	Mandrin acier auto. 10mm	56,05 €
<b>AIMF19006</b>	Mandrin acier à clé 10mm	21,10 €
<b>AIMF19003</b>	Clé de mandrin 10mm	3,25 €
<b>AIMF19007</b>	Clé de mandrin 13mm	3,90 €



<b>AITD99</b>	TETE A DEPOINTER <b>AIROUTIL</b> fabrication française modèle déposé	<b>supprimé</b>
---------------	---	-----------------

### FORETS A DEPOINTER

<b>FORETS POUR AITD99 AIROUTIL Long. 37mm</b>		
<b>AIFTD99U</b>	Forêt à dépointer TIN 8mm pour TD99	* 20,80 €
<b>AIFTD99</b>	5 forêts à dépointer TIN 8mm	* 96,20 €

<b>FORETS POUR DP88 AIROUTIL Long. 40mm</b>		
<b>AIFDP100U</b>	Forêt à dépointer TIN 8mm pour DP88	* 24,05 €
<b>AIFDP100</b>	5 forêts à dépointer TIN 8mm pour DP88	* 111,40 €

<b>FORETS POUR DEPOINTEUR STANDARD Long. 44mm</b>		
<b>AIFDS44U</b>	Forêt à dépointer TIN 8mm	24,05 €
<b>AIFDS44</b>	5 forêts à dépointer TIN 8mm	111,40 €

<b>FORETS A DEPOINTER POUR PERCEUSES</b>		
<b>AIFDL666</b>	Forêt à dépointer TIALN 6mm pour tôle THLE	* 17,55 €
<b>AIFDL773</b>	Forêt à dépointer TIALN 7mm pour tôle THLE	* 19,10 €
<b>AIFDL879</b>	Forêt à dépointer TIALN 8mm pour tôle THLE	* 20,80 €
<b>AIFDL1088</b>	Forêt à dépointer TIALN 10mm pour tôle THLE	* 26,55 €

\* voir grille remises quantitatives

<b>AIHC</b>	Bidon 200ml d'huile de coupe et perçage	15,35 €
-------------	---	---------



# CONSOMMABLES



FRAISE CONIQUE ETAGEE		
AIFCE4-12	Fraise conique étagée HSS 4-12mm	19,65 €
AIFCE4-20	Fraise conique étagée HSS 4-20mm	30,85 €
AIFCE6-30	Fraise conique étagée HSS 6-30mm	73,60 €
AIFCE6-38	Fraise conique étagée HSS 6-38mm	102,70 €

AIFC.CO6.20	Fraise conique HSS-CO 6-20mm	51,35 €
AIFC.CO6.30	Fraise conique HSS-CO 6-30mm	102,70 €

AIFCHET4.12	Fraise conique hélic.étagée TIALN 4-12mm	41,90 €
AIFCHET4.20	Fraise conique hélic.étagée TIALN 4-20mm	61,10 €
AIFCHET6.30	Fraise conique hélic.étagée TIALN 6.30mm	121,80 €
AIFCHET6.38	Fraise conique hélic.étagée TIALN 6.38mm	169,55 €



FORETS HSS DIN 338 (également disponibles en HSS-CO)		
AIFS1,0	Pochette 10 forêts HSS 1,0mm	3,35 €
AIFS1,5	Pochette 10 forêts HSS 1,5mm	3,45 €
AIFS2,0	Pochette 10 forêts HSS 2,0mm	4,20 €
AIFS2,5	Pochette 10 forêts HSS 2,5mm	5,25 €
AIFS3,0	Pochette 10 forêts HSS 3,0mm	6,40 €
AIFS3,5	Pochette 10 forêts HSS 3,5mm	6,60 €
AIFS4,0	Pochette 10 forêts HSS 4,0mm	9,35 €
AIFS4,2	Pochette 10 forêts HSS 4,2mm	9,55 €
AIFS4,5	Pochette 10 forêts HSS 4,5mm	9,75 €
AIFS5,0	Pochette 10 forêts HSS 5,0mm	10,70 €
AIFS5,2	Pochette 10 forêts HSS 5,2mm	14,60 €
AIFS5,5	Pochette 10 forêts HSS 5,5mm	14,80 €
AIFS6,0	Pochette 10 forêts HSS 6,0mm	16,40 €
AIFS6,5	Pochette 10 forêts HSS 6,5mm	17,55 €
AIFS7,0	Pochette 10 forêts HSS 7,0mm	22,45 €
AIFS7,5	Pochette 10 forêts HSS 7,5mm	25,20 €
AIFS8,0	Pochette 10 forêts HSS 8,0mm	32,55 €
AIFS8,5	Pochette 10 forêts HSS 8,5mm	34,75 €
AIFS9,0	Pochette 10 forêts HSS 9,0mm	40,75 €
AIFS9,5	Pochette 10 forêts HSS 9,5mm	42,10 €
AIFS10,0	Pochette 10 forêts HSS 10,0mm	52,50 €

COFFRETS DE FORETS		
AIFSC12	12 forêts HSS 1-7mm/0,5mm +8mm	40,40 €

AIFSC19	19 forêts HSS 1-10mm / par 0,5mm	44,60 €
AIFSCOC19	19 forêts HSS-CO 1-10mm / par 0,5mm	76,45 €

AIFSC25	25 forêts HSS 1-13mm / par 0,5mm	100,15 €
AIFSCOC25	25 forêts HSS-CO 1-13mm / par 0,5mm	163,05 €

AIA6DG	Axe 6mm pour disque gomme	4,85 €
AIDG76	Disque gomme 76mm pour filet	15,75 €

ROUES DE DECAPAGE TYPE ROLOC		
AIA6RR	Axe 6mm pour roue type ROLOC	8,70 €
AIRD76	Bte 10 roues de décapage 76x13mm	101,65 €

AIBTAA6	Brosse torsadée fil acier	11,85 €
---------	---------------------------	---------





## DISQUEUSES 125 / 180mm



**AIDRA18B** Disqueuse revolver 125mm intensive avec régulateur dans la poignée 86,75 €



**AIDR19C** Disqueuse revolver réversible 125mm intensive 193,20 €



PLATEAUX DE DISQUEUSE REVOLVER		
AIDRA1828	jeu 3 supports fibre 50/75/125mm	17,85 €
AIDR17020	Plateau composite 110mm	11,95 €
AIDR1950	Plateau nylon ventilé 115mm	19,95 €
AIADR	Adaptateur pour disques type ROLOC pour disqueuse revolver	20,70 €



**AIDR20** Disqueuse d'angle 180mm standard 302,40 €



**AIDV21** Disqueuse verticale 180mm intensive 217,55 €

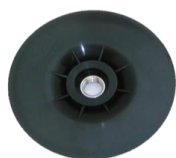

PLATEAU POUR DISQUEUSE 180MM		
AIDR2055	Plateau F5/8 nylon 180mm	16,25 €
AIDR2055S	Plateau F5/8 nylon semi-souple 180mm	24,65 €

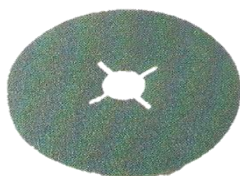

DISQUES FIBRE ZIRCONIUM 115/125/180MM		
AIDF11524	25 disques fibre 115mm P24	31,80 €
AIDF11536	25 disques fibre 115mm P36	28,55 €
AIDF11560	25 disques fibre 115mm P60	25,60 €
AIDF11580	25 disques fibre 115mm P80	26,55 €
AIDF12524	25 disques fibre 125mm P24	33,50 €
AIDF12536	25 disques fibre 125mm P36	32,85 €
AIDF12550	25 disques fibre 125mm P50	30,95 €
AIDF12560	25 disques fibre 125mm P60	28,55 €
AIDF12580	25 disques fibre 125mm P80	27,60 €
AIDF18024	25 disques fibre 180mm P24	55,55 €
AIDF18036	25 disques fibre 180mm P36	54,50 €
AIDF18050	25 disques fibre 180mm P50	51,25 €
AIDF18060	25 disques fibre 180mm P60	54,70 €
AIDF18080	25 disques fibre 180mm P80	51,45 €

## MEULEUSE D'ANGLE



**AIROUTIL**



<b>AIM125</b>	Meuleuse d'angle gainée 125mm	295,05 €
---------------	-------------------------------	----------



<b>AIPDF125</b>	Plateau F5/8" nylon semi-souple pour disque fibre 125mm	13,35 €
-----------------	---	---------

## MEULES ET DISQUES A LAMELLES

MEULES PLATES FINES 125MM		
<b>AIMPM1251</b>	25 meules <b>métal</b> 125x1x22mm	44,85 €
<b>AIMPI1251</b>	25 meules <b>inox</b> 125x1x22mm	46,00 €
<b>AIMPA1251</b>	25 meules <b>alu</b> 125x1,6x22mm	50,30 €



MEULES PLATES 125MM		
<b>AIMPM1252</b>	25 meules <b>métal</b> 125x2,5x22mm	48,70 €
<b>AIMPI1252</b>	25 meules <b>inox</b> 125x2,5x22mm	50,60 €

MEULES MOYEU DEPORTE 125MM		
<b>AIMDM1253</b>	25 meules <b>métal</b> 125x3x22mm	48,70 €

MEULES MOYEU DEPORTE EBARBAGE 125MM		
<b>AIMDM1256</b>	25 meules <b>métal</b> 125x6,5x22mm	72,45 €
<b>AIMDI1256</b>	25 meules <b>inox</b> 125x6,5x22mm	74,75 €



DISQUES A LAMELLES ZIRCONIUM 125MM		
<b>AIDL12740</b>	10 disques plats P40	36,45 €
<b>AIDL12760</b>	10 disques plats P60	36,45 €
<b>AIDL12780</b>	10 disques plats P80	36,45 €
<b>AIDL127120</b>	10 disques plats P120	36,45 €
<b>AIDLC12740</b>	10 disques coniques P40	30,85 €
<b>AIDLC12760</b>	10 disques coniques P60	30,85 €
<b>AIDLC12780</b>	10 disques coniques P80	30,85 €
<b>AIDLC127120</b>	10 disques coniques P120	30,85 €

## BURINEUR



**AIROUTIL**



<b>AIBC10C</b>	Burineur cylindrique 10 mm en coffret avec 5 outils standards	191,10 €
----------------	---	----------

## ACCESSOIRES BURINEURS



<b>AIRTOB</b>	Ressort de retenue ouvert	10,80 €
---------------	---------------------------	---------



<b>AIROBB</b>	Retenue d'outil à billes	27,50 €
---------------	--------------------------	---------



<b>AITBC10</b>	Tas pour le démontage des rotules	52,80 €
----------------	-----------------------------------	---------

## GRATTOIR ET DECAPEUR



<b>AIGDC</b>	Grattoir pneumatique en coffret	168,10 €
--------------	---------------------------------	----------

<b>AIL25GD</b>	Lame droite standard pour grattoir	15,10 €
----------------	------------------------------------	---------



<b>AIMA19</b>	Pistolet décapeur 19 aiguilles	404,25 €
---------------	--------------------------------	----------

<b>AIJ19AM</b>	Jeu de 19 aiguilles	27,60 €
----------------	---------------------	---------

## GRIGNOTEUSE



**AIROUTIL**



<b>AIGR12</b>	Grignoteuse ACIER 0,8mm ALU 1,6mm	156,95 €
<b>AIGR12.1</b>	Poinçon 3,5mm	10,90 €
<b>AIGR12.2</b>	Matrice	36,85 €

## CRAYON A GRAVER



<b>AIGR1</b>	Crayon à graver	183,35 €
<b>AIGR10</b>	Pointe carbure à graver	55,65 €

## RIVETEUSES



<b>AIRV1</b>	Riveteuse rivet ALU 4,8 maxi.	215,25 €
--------------	-------------------------------	----------

<b>AIRV2</b>	Riveteuse rivet ALU 6,4mm maxi. rivet ACIER 4,8mm maxi.	455,15 €
--------------	--	----------



<b>AIRV3</b>	Riveteuse rivet ACIER 6,4mm maxi. avec aspiration des tiges	855,75 €
--------------	--	----------

## RIVETS SPECIAUX POUR PLAQUES D'IMMATRICULATION BLANCS



<b>AIREB416</b>	Bte 500 rivets éclatés 4x16mm tête 8mm TR	39,50 €
<b>AIREBTL416</b>	Bte 250 rivets éclatés 4x16mm tête 12mm TL	24,15 €
<b>AIREB4816</b>	Bte 250 rivets éclatés 4,8x16mm tête 9,5mm TR	24,15 €
<b>AIREBTL4816</b>	Bte 250 rivets éclatés 4,8x16mm tête 14mm TL	33,50 €



<b>AIREPB418</b>	Bte 250 rivets expansés 4x18mm tête 8mm TR	38,20 €
<b>AIREPB424</b>	Bte 250 rivets expansés 4x24mm tête 8mm TR	43,90 €



<b>AICB</b>	Bte 500 capuchons blancs pour tête 9,5mm maxi	43,15 €
-------------	---	---------



## CLES A CLIQUET



**AIROUTIL**



**AICR2C** Clé à cliquet gainée 1/4 30 Nm 157,40 €



**AICR6** Clé à cliquet 1/2 60 Nm 113,30 €



**AICR5C** Clé à cliquet gainée 3/8 70 Nm 157,40 €

**AICR7C** Clé à cliquet gainée 1/2 70 Nm 157,40 €

## CLES A CHOCS



**AICC10** Clé à chocs compacte 3/8 100 Nm 95,15 €

**AICC108** Clé + jeu 8 douilles à chocs 3/8 119,70 €



**AICLE54B** Clé à chocs 1/2 540 Nm double marteau 244,25 €

**AICLE54BC** Clé + jeu 10 douilles à chocs 1/2 329,80 €



**AICC9C** Clé à chocs 1/2 " 980 Nm  
Intensive double marteau 274,70 €



**AICC16** Clé à chocs revolver 3/4 1500 Nm  
Intensive double marteau 663,05 €



**AICC24** Clé à chocs revolver 1" broche courte  
2200 Nm Intensive 871,70 €

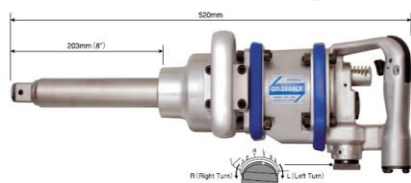

**AICCDL24** Clé à chocs droite 1" broche longue  
2300 Nm Intensive 977,55 €

**AICCD24** Clé à chocs droite 1" broche courte  
2300 Nm Intensive 910,65 €

## EMBOUT DE VISSAGE A CHOCS TORX A VERROUILLAGE RAPIDE



**AIROUTIL**



<b>KO/AS14105C</b>	Coffret TORX complet de 11 pièces	116,15 €
<b>KO/14105L</b>	Douille à chocs 1/2" porte embout de 11mm	31,90 €
<b>KO/107.11/35T30</b>	Embout à chocs Lg.35mm TORX 30	7,55 €
<b>KO/107.11/35T40</b>	Embout à chocs Lg.35mm TORX 40	7,55 €
<b>KO/107.11/35T45</b>	Embout à chocs Lg.35mm TORX 45	7,55 €
<b>KO/107.11/35T50</b>	Embout à chocs Lg.35mm TORX 50	7,65 €
<b>KO/107.11/35T55</b>	Embout à chocs Lg.35mm TORX 55	7,65 €
<b>KO/107.11/80T30</b>	Embout à chocs Lg.80mm TORX 30	8,50 €
<b>KO/107.11/80T40</b>	Embout à chocs Lg.80mm TORX 40	8,50 €
<b>KO/107.11/80T45</b>	Embout à chocs Lg.80mm TORX 45	8,50 €
<b>KO/107.11/80T50</b>	Embout à chocs Lg.80mm TORX 50	8,50 €
<b>KO/107.11/80T55</b>	Embout à chocs Lg.80mm TORX 55	8,50 €

Embouts TORX 60, XZN et 6 pans sur demande.

## COFFRETS DE DOUILLES



<b>AICR730</b>	Coffret 8 douilles à chocs <b>3/8"</b> (8/10/11/12/13/14/17/19mm)	20,60 €
----------------	--	---------



<b>AICR731</b>	Coffret 8 douilles à chocs longues <b>3/8"</b> (8/10/11/12/13/14/17/19mm)	45,65 €
----------------	--	---------



<b>AICD1/2</b>	Coffret 13 douilles à chocs <b>1/2"</b> (10/11/12/13/14/16/17/19/21/22/24/27/30mm)	47,90 €
----------------	---	---------



<b>AICD1/2L</b>	Coffret 13 douilles à chocs longues <b>1/2"</b> (10/11/12/13/14/16/17/19/21/22/24/27/30mm)	88,50 €
-----------------	---	---------



<b>AICD3/4</b>	Coffret 8 douilles à chocs <b>3/4"</b> (19/22/24/27/28/30/32/33mm)	90,70 €
----------------	---	---------



<b>AIDO12</b>	Coffret 9 douilles à chocs <b>1"</b> (26/27/29/32/35/38/41/46/50mm)	134,70 €
---------------	--	----------

## ACCESSOIRES A CHOCS



**AIROUTIL**



**KO4112G** Tournevis à chocs 1/2 **42,50 €**



### AUGMENTATEUR / REDUCTEUR

<b>KF381340</b>	Augmentateur	F1/2"-M3/4"		<b>19,20 €</b>
<b>KO16688A</b>	Augmentateur	F3/4"-M1"		<b>34,10 €</b>
<b>KO16644A</b>	Réducteur	F3/4"-M1/2"	*	<b>27,40 €</b>
<b>KO18866A</b>	Réducteur	F1"-M3/4"	*	<b>41,70 €</b>

\*Pas de garantie à la rupture

## DOUILLES SPECIFIQUES



### DOUILLE 12 PANS PAROI MINCE POUR TRANSMISSION

<b>CLOM0055</b>	Douille 1/2" 12 pans longue de 35 mm	<b>39,70 €</b>
<b>CLOM0056</b>	Douille 1/2" 12 pans longue de 36 mm	<b>49,25 €</b>
<b>KO18405M65D87</b>	Douille 1" 12 pans de 65 mm épaulée	<b>102,15 €</b>

<b>KO16301M41</b>	Douille 3/4" 6 pans longue de 41 mm	<b>51,25 €</b>
<b>KO16301M42</b>	Douille 3/4" 6 pans longue de 42 mm	<b>56,05 €</b>



### DOUILLE SPECIALE SUPPORT DE BOITE MOTEUR PSA

<b>KO14301M.120.16</b>	Douille 1/2" 16 mm Lg, 120mm	<b>71,80 €</b>
------------------------	------------------------------	----------------



<b>KO14124/3</b>	Kit de démontage pour écrou antivol 2 douilles réversibles et une allonge 1/2"	<b>104,35 €</b>
------------------	---	-----------------

## DOUILLES A CONTRÔLE DE COUPLE



### DOUILLES A CONTRÔLE DE COUPLE 1/2" CODE COULEUR V.L.

<b>14101MP/8</b>	Tableau de 8 douilles à contrôle de couple	<b>256,60 €</b>
<b>14101MP-17/110</b>	17 mm par 110 N.m	<b>32,00 €</b>
<b>14101MP-17/120</b>	17 mm par 120 N.m	<b>32,00 €</b>
<b>14101MP-19/90</b>	19 mm par 90 N.m	<b>32,65 €</b>
<b>14101MP-19/100</b>	19 mm par 100 N.m	<b>32,65 €</b>
<b>14101MP-19/120</b>	19 mm par 120 N.m	<b>32,65 €</b>
<b>14101MP-19/140</b>	19 mm par 140 N.m	<b>32,65 €</b>
<b>14101MP-21/100</b>	21 mm par 100 N.m	<b>34,85 €</b>

Existe en 21/120 N.m et 22/150 N.m sur demande



### DOUILLES A CONTROLE DE COUPLE 1" P.L.

<b>18101M-24/350</b>	Douille 1" de 24 mm par 350 N.m	<b>99,20 €</b>
<b>18101M-27/350</b>	Douille 1" de 27 mm par 350 N.m	<b>99,20 €</b>
<b>18101M-27/450</b>	Douille 1" de 27 mm par 450 N.m	<b>99,20 €</b>
<b>18101M-29/400</b>	Douille 1" de 29 mm par 400 N.m	<b>99,20 €</b>
<b>18101M-30/500</b>	Douille 1" de 30 mm par 500 N.m	<b>103,00 €</b>
<b>18101M-32/450</b>	Douille 1" de 32 mm par 450 N.m	<b>107,50 €</b>
<b>18101M-32/600</b>	Douille 1" de 32 mm par 600 N.m	<b>107,50 €</b>
<b>18101M-33/600</b>	Douille 1" de 33 mm par 600 N.m	<b>107,50 €</b>

\*Attention ne pas utiliser au desserrage, en cas de rupture la garantie ne serait pas appliquée.

**DOUILLES 1/2 A CHOCS  
6 PANS PAROI MINCE**



Référence	Carré	Taille (mm)	D1 (mm)	D2 (mm)	Long. (mm)	Tarif H.T
KO14401M8	1/2	8	13,0	24	38	8,50 €
KO14401M9	1/2	9	14,2	24	38	8,60 €
KO14401M10	1/2	10	15,5	24	38	8,80 €
KO14401M11	1/2	11	16,7	24	38	9,05 €
KO14401M12	1/2	12	18,0	24	38	9,25 €
KO14401M13	1/2	13	19,2	24	38	9,45 €
KO14401M14	1/2	14	20,5	24	38	9,55 €
KO14401M15	1/2	15	21,7	29	38	9,65 €
KO14401M16	1/2	16	23,0	29	38	9,75 €
KO14401M17	1/2	17	24,2	29	38	9,95 €
KO14401M18	1/2	18	25,5	29	38	10,20 €
KO14401M19	1/2	19	26,7	29	38	10,50 €
KO14401M20	1/2	20	28,0	29	38	10,60 €
KO14401M21	1/2	21	29,2	29	38	10,80 €
KO14401M22	1/2	22	30,5	29	38	11,25 €
KO14401M23	1/2	23	31,7	29	38	11,65 €
KO14401M24	1/2	24	33,0	29	38	11,85 €
KO14401M25	1/2	25	34,2	29	38	12,05 €
KO14401M26	1/2	26	35,5	29	38	12,70 €
KO14401M27	1/2	27	36,7	29	40	13,10 €
KO14401M28	1/2	28	38,0	29	40	14,05 €
KO14401M29	1/2	29	39,2	29	42	14,40 €
KO14401M30	1/2	30	40,5	29	42	15,45 €
KO14401M31	1/2	31	41,7	29	42	15,85 €
KO14401M32	1/2	32	43,0	29	42	17,20 €
KO14401M33	1/2	33	44,2	29	46	25,10 €
KO14401M34	1/2	34	45,5	29	46	25,40 €
KO14401M36	1/2	36	48,0	29	46	26,05 €

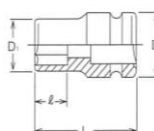

**DOUILLES 1/2 A CHOCS 12 PANS PAROI MINCE**

Références	Carré	Taille (mm)	D1 (mm)	D2 (mm)	Long. (mm)	Tarif H.T
KO14406M8	1/2	8	13,0	24	38	8,80 €
KO14406M9	1/2	9	14,2	24	38	9,05 €
KO14406M10	1/2	10	15,5	24	38	9,25 €
KO14406M11	1/2	11	16,7	24	38	9,35 €
KO14406M12	1/2	12	18,0	24	38	9,65 €
KO14406M13	1/2	13	19,2	24	38	9,85 €
KO14406M14	1/2	14	20,5	24	38	9,95 €
KO14406M15	1/2	15	21,7	29	38	10,10 €
KO14406M16	1/2	16	23,0	29	38	10,30 €
KO14406M17	1/2	17	24,2	29	38	10,50 €
KO14406M18	1/2	18	25,5	29	38	10,60 €
KO14406M19	1/2	19	26,7	29	38	10,80 €
KO14406M20	1/2	20	28,0	29	38	11,25 €
KO14406M21	1/2	21	29,2	29	38	11,45 €
KO14406M22	1/2	22	30,5	29	38	11,75 €
KO14406M23	1/2	23	31,7	29	38	12,30 €
KO14406M24	1/2	24	33,0	29	38	12,60 €
KO14406M25	1/2	25	34,2	29	38	12,90 €
KO14406M26	1/2	26	35,5	29	38	13,35 €
KO14406M27	1/2	27	36,7	29	40	13,75 €
KO14406M28	1/2	28	38,0	29	40	14,70 €
KO14406M29	1/2	29	39,2	29	42	15,45 €
KO14406M30	1/2	30	40,5	29	42	16,25 €
KO14406M31	1/2	31	41,7	29	42	16,70 €
KO14406M32	1/2	32	43,0	29	42	17,95 €
KO14406M33	1/2	33	44,2	29	46	26,35 €
KO14406M34	1/2	34	45,5	29	46	26,75 €
KO14406M36	1/2	36	48,0	29	46	27,50 €

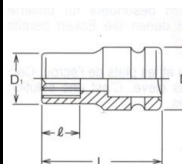



**DOUILLES 1/2 A CHOCS**  
**MI-LONGUES 6 PANS PAROI MINCE**



**KORS14301X** Jeu de 10 douilles sur rail 10, 12, 13, 14, 17, 19, 21, 22, 24, 27mm

**139,95 €**

Référence	Carré	Taille (mm)	D1 (mm)	D2 (mm)	Long. (mm)	Tarif H.T
KO14301X8	1/2	8	13,0	24	60	14,50 €
KO14301X10	1/2	10	15,5	24	60	14,70 €
KO14301X11	1/2	11	16,7	24	60	14,80 €
KO14301X12	1/2	12	18,0	24	60	14,90 €
KO14301X13	1/2	13	19,2	24	60	15,00 €
KO14301X14	1/2	14	20,5	24	60	15,20 €
KO14301X15	1/2	15	21,7	29	60	15,45 €
KO14301X16	1/2	16	23,0	29	60	15,55 €
KO14301X17	1/2	17	24,2	29	60	15,65 €
KO14301X19	1/2	19	26,7	29	60	15,75 €
KO14301X21	1/2	21	29,2	29	60	16,80 €
KO14301X22	1/2	22	30,5	29	65	17,30 €
KO14301X23	1/2	23	31,7	29	65	17,95 €
KO14301X24	1/2	24	33,0	29	65	18,35 €
KO14301X26	1/2	26	35,5	29	65	20,15 €
KO14301X27	1/2	27	36,7	29	65	21,10 €

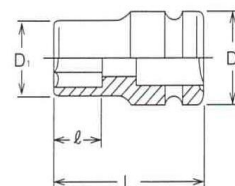

**DOUILLES 1/2 A CHOCS**  
**LONGUES 6 PANS PAROI MINCE**

Référence	Carré	Taille (mm)	D1 (mm)	D2 (mm)	Long. (mm)	Tarif H.T
KO14301M8	1/2	8	13,0	24	80	15,35 €
KO14301M9	1/2	9	14,2	24	80	15,45 €
KO14301M10	1/2	10	15,5	24	80	15,65 €
KO14301M11	1/2	11	16,7	24	80	15,85 €
KO14301M12	1/2	12	18,0	24	80	16,00 €
KO14301M13	1/2	13	19,2	24	80	16,10 €
KO14301M14	1/2	14	20,5	24	80	16,40 €
KO14301M15	1/2	15	21,7	29	80	16,40 €
KO14301M16	1/2	16	23,0	29	80	16,45 €
KO14301M17	1/2	17	24,2	29	80	16,50 €
KO14301M18	1/2	18	25,5	29	80	16,55 €
KO14301M19	1/2	19	26,7	29	80	16,90 €
KO14301M20	1/2	20	28,0	29	80	17,30 €
KO14301M21	1/2	21	29,2	29	80	17,65 €
KO14301M22	1/2	22	30,5	29	85	18,40 €
KO14301M23	1/2	23	31,7	29	85	19,10 €
KO14301M24	1/2	24	33,0	29	85	20,05 €
KO14301M25	1/2	25	34,2	29	85	20,90 €
KO14301M26	1/2	26	35,5	29	85	21,65 €
KO14301M27	1/2	27	36,7	29	85	22,25 €
KO14301M28	1/2	28	38,0	29	85	24,65 €
KO14301M29	1/2	29	39,2	29	85	26,55 €
KO14301M30	1/2	30	40,5	29	85	27,70 €
KO14301M31	1/2	31	41,7	29	85	28,85 €
KO14301M32	1/2	32	43,0	29	85	31,95 €
KO14301M34	1/2	34	45,5	29	85	36,35 €
KO14301M35	1/2	35	46,7	29	85	41,05 €
KO14301M36	1/2	36	48,0	29	85	46,50 €

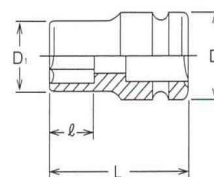

**DOUILLES 1/2 A CHOCS  
LONGUES 12 PANS PAROI MINCE**



Référence	Carré	Taille (mm)	D1 (mm)	D2 (mm)	Long. (mm)	Tarif H.T
KO14306M12	1/2	12	18,0	24	80	16,80 €
KO14306M13	1/2	13	19,2	24	80	17,20 €
KO14306M14	1/2	14	20,5	24	80	17,30 €
KO14306M15	1/2	15	21,7	29	80	17,65 €
KO14306M16	1/2	16	23,0	29	80	17,70 €
KO14306M17	1/2	17	24,2	29	80	17,75 €
KO14306M18	1/2	18	25,5	29	80	17,85 €
KO14306M19	1/2	19	26,7	29	80	18,40 €
KO14306M21	1/2	21	29,2	29	80	19,10 €
KO14306M22	1/2	22	30,5	29	85	19,75 €
KO14306M24	1/2	24	33,0	29	85	20,60 €
KO14306M27	1/2	27	36,7	29	85	23,95 €
KO14306M30	1/2	30	40,5	29	85	28,65 €
KO14306M32	1/2	32	43,0	29	85	31,20 €

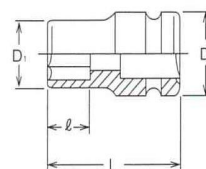

**DOUILLES 3/4 A CHOCS  
6 PANS PAROI MINCE**

Référence	Carré	Taille (mm)	D1 (mm)	D2 (mm)	Long. (mm)	Tarif H.T
KO16401M17	3/4	17	28,0	43	50	20,40 €
KO16401M18	3/4	18	29,3	43	50	20,60 €
KO16401M19	3/4	19	30,5	43	50	20,80 €
KO16401M20	3/4	20	31,8	43	50	20,90 €
KO16401M21	3/4	21	33,0	43	50	21,00 €
KO16401M22	3/4	22	34,3	43	50	21,10 €
KO16401M23	3/4	23	35,5	43	50	21,20 €
KO16401M24	3/4	24	36,8	43	50	21,30 €
KO16401M25	3/4	25	38,0	43	50	21,40 €
KO16401M26	3/4	26	39,3	43	50	21,50 €
KO16401M27	3/4	27	40,5	43	50	21,65 €
KO16401M28	3/4	28	41,8	43	50	21,75 €
KO16401M29	3/4	29	43,0	43	53	21,85 €
KO16401M30	3/4	30	44,3	43	53	21,95 €
KO16401M30	3/4	31	45,5	43	53	22,15 €
KO16401M32	3/4	32	46,8	43	53	22,90 €
KO16401M33	3/4	33	48,0	43	55	25,10 €
KO16401M34	3/4	34	49,3	43	55	25,50 €
KO16401M35	3/4	35	50,5	43	55	25,70 €
KO16401M36	3/4	36	51,8	43	55	26,15 €
KO16401M37	3/4	37	53,0	43	55	29,40 €
KO16401M38	3/4	38	54,3	43	57	30,85 €
KO16401M40	3/4	40	56,8	43	57	32,25 €
KO16401M41	3/4	41	58,0	43	57	33,50 €
KO16401M42	3/4	42	59,3	43	57	35,15 €
KO16401M44	3/4	44	61,8	43	62	37,50 €
KO16401M46	3/4	46	64,3	43	62	38,65 €

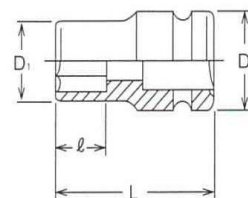

## DOUILLES 3/4 A CHOCS MI-LONGUES 6 PANS PAROI MINCE



**AIROUTIL**<sup>®</sup>

Référence	Carré	Taille (mm)	D1 (mm)	D2 (mm)	Long. (mm)	Tarif H.T
KO16301X18	3/4	18	29,3	43	75	33,50 €
KO16301X19	3/4	19	30,5	43	75	33,80 €
KO16301X20	3/4	20	31,8	43	75	34,10 €
KO16301X21	3/4	21	33,0	43	75	34,45 €
KO16301X22	3/4	22	34,3	43	75	34,75 €
KO16301X23	3/4	23	35,5	43	75	34,95 €
KO16301X24	3/4	24	36,8	43	75	35,40 €
KO16301X25	3/4	25	38,0	43	75	35,90 €
KO16301X26	3/4	26	39,3	43	75	36,35 €
KO16301X27	3/4	27	40,5	43	75	36,55 €
KO16301X28	3/4	28	41,8	43	75	36,75 €
KO16301X29	3/4	29	43,0	43	75	36,95 €
KO16301X30	3/4	30	44,3	43	75	37,25 €
KO16301X31	3/4	31	45,5	43	75	37,50 €
KO16301X32	3/4	32	46,8	43	75	37,70 €
KO16301X35	3/4	35	50,5	43	75	40,40 €
KO16301X36	3/4	36	51,8	43	75	43,45 €
KO16301X37	3/4	37	53,0	43	75	46,50 €
KO16301X38	3/4	38	54,3	43	80	47,65 €
KO16301X40	3/4	40	56,8	43	80	49,65 €
KO16301X41	3/4	41	58,0	43	80	51,15 €
KO16301X46	3/4	46	64,3	43	80	63,50 €

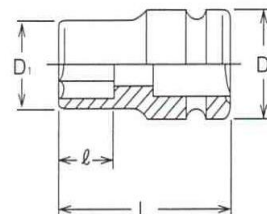

## DOUILLES 3/4 A CHOCS LONGUES 6 PANS PAROI MINCE

Référence	Carré	Taille (mm)	D1 (mm)	D2 (mm)	Long. (mm)	Tarif H.T
KO16301M17	3/4	17	28,0	43	100	34,10 €
KO16301M18	3/4	18	29,3	43	100	34,35 €
KO16301M19	3/4	19	30,5	43	100	34,55 €
KO16301M20	3/4	20	31,8	43	100	34,85 €
KO16301M21	3/4	21	33,0	43	100	35,15 €
KO16301M22	3/4	22	34,3	43	100	35,40 €
KO16301M23	3/4	23	35,5	43	100	35,60 €
KO16301M24	3/4	24	36,8	43	100	36,00 €
KO16301M25	3/4	25	38,0	43	100	36,20 €
KO16301M26	3/4	26	39,3	43	100	36,55 €
KO16301M27	3/4	27	40,5	43	100	36,75 €
KO16301M28	3/4	28	41,8	43	100	36,95 €
KO16301M29	3/4	29	43,0	43	100	37,25 €
KO16301M30	3/4	30	44,3	43	100	37,60 €
KO16301M31	3/4	31	45,5	43	100	37,90 €
KO16301M32	3/4	32	46,8	43	100	38,10 €
KO16301M33	3/4	33	48,0	43	100	39,90 €
KO16301M34	3/4	34	49,3	43	100	42,00 €
KO16301M35	3/4	35	50,5	43	100	43,15 €
KO16301M36	3/4	36	51,8	43	100	44,40 €
KO16301M37	3/4	37	53,0	43	100	46,40 €
KO16301M38	3/4	38	54,3	43	100	48,20 €
KO16301M40	3/4	40	56,8	43	100	49,35 €
KO16301M41	3/4	41	58,0	43	100	50,20 €
KO16301M42	3/4	42	59,3	43	100	54,90 €
KO16301M46	3/4	46	64,3	43	100	64,35 €

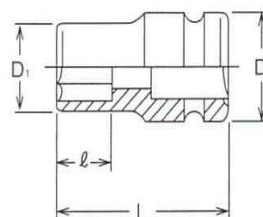

### DOUILLES 1" A CHOCS 6 PANS PAROI MINCE

Référence	Carré	Taille (mm)	D1 (mm)	D2 (mm)	Long. (mm)	Tarif H.T
KO18401M17	1"	17	29,8	53	57	33,60 €
KO18401M21	1"	21	34,8	53	57	34,25 €
KO18401M22	1"	22	36,0	53	57	34,45 €
KO18401M24	1"	24	38,5	53	57	34,65 €
KO18401M27	1"	27	42,3	53	57	34,85 €
KO18401M30	1"	30	46,0	53	62	35,05 €
KO18401M32	1"	32	48,5	53	62	35,40 €
KO18401M33	1"	33	49,8	53	62	35,60 €
KO18401M35	1"	35	52,3	53	62	35,90 €
KO18401M36	1"	36	53,5	53	62	36,10 €
KO18401M38	1"	38	56,0	53	66	40,65 €
KO18401M41	1"	41	59,8	53	66	45,25 €
KO18401M46	1"	46	66,0	53	70	48,00 €
KO18401M50	1"	50	71,0	53	70	60,60 €



### DOUILLES 1" A CHOCS MI-LONGUES 6 PANS PAROI MINCE

Référence	Carré	Taille (mm)	D1 (mm)	D2 (mm)	Long. (mm)	Tarif H.T
KO18301X17	1"	17	29,8	53	80	55,00 €
KO18301X19	1"	19	32,3	53	80	56,05 €
KO18301X21	1"	21	34,8	53	80	57,00 €
KO18301X22	1"	22	36,0	53	80	58,05 €
KO18301X24	1"	24	38,5	53	80	59,00 €
KO18301X27	1"	27	42,3	53	80	59,65 €
KO18301X30	1"	30	46,0	53	80	60,65 €
KO18301X32	1"	32	48,5	53	85	61,65 €
KO18301X33	1"	33	49,8	53	85	62,70 €
KO18301X35	1"	35	52,3	53	85	63,30 €
KO18301X36	1"	36	53,5	53	85	64,25 €
KO18301X38	1"	38	56,0	53	85	66,45 €
KO18301X41	1"	41	59,8	53	85	71,30 €
KO18301X46	1"	46	66,0	53	85	73,85 €
KO18301X50	1"	50	71,0	53	85	87,65 €



### DOUILLES 1" A CHOCS LONGUES 6 PANS PAROI MINCE

Référence	Carré	Taille (mm)	D1 (mm)	D2 (mm)	Long. (mm)	Tarif H.T
KO18301M17	1"	17	29,8	53	108	54,40 €
KO18301M19	1"	19	32,3	53	108	54,50 €
KO18301M21	1"	21	34,8	53	108	54,60 €
KO18301M22	1"	22	36,0	53	108	54,65 €
KO18301M23	1"	23	37,3	53	108	54,70 €
KO18301M24	1"	24	38,5	53	108	54,75 €
KO18301M26	1"	26	41,0	53	108	54,80 €
KO18301M27	1"	27	42,3	53	108	54,85 €
KO18301M29	1"	29	44,8	53	108	54,90 €
KO18301M30	1"	30	46,0	53	108	54,95 €
KO18301M32	1"	32	48,5	53	108	55,00 €
KO18301M33	1"	33	49,8	53	108	55,10 €
KO18301M35	1"	35	52,3	53	108	55,25 €
KO18301M36	1"	36	53,5	53	108	61,55 €
KO18301M38	1"	38	56,0	53	108	67,10 €
KO18301M39	1"	39	57,3	53	108	67,60 €
KO18301M41	1"	41	59,8	53	108	68,05 €
KO18301M43	1"	43	62,3	53	108	68,55 €
KO18301M46	1"	46	66,0	53	108	75,40 €
KO18301M50	1"	50	71,0	53	108	85,35 €



## SOUFFLETTES



<b>AISM240</b>	Soufflette métal	(1)	*	16,60 €
----------------	------------------	-----	---	---------

<b>AISBC</b>	Soufflette du peintre	(2)	*	8,40 €
--------------	-----------------------	-----	---	--------

<b>AISP06</b>	Soufflette stylo	(3)	*	11,35 €
---------------	------------------	-----	---	---------

<b>AISP</b>	Soufflette composite	(4)	*	9,75 €
-------------	----------------------	-----	---	--------

<b>AISPM</b>	Soufflette à poignée métal	(5)	*	10,80 €
--------------	----------------------------	-----	---	---------

<b>AISPML</b>	Soufflette métal bec long	(6)	*	11,95 €
---------------	---------------------------	-----	---	---------

## PISTOLETS



<b>AIPC2</b>	Pistolet à cartouche 310/400 ml	62,60 €
--------------	---------------------------------	---------



<b>AIPCS2</b>	Pistolet à extruder professionnel Cartouche et sachet 310/400 ml Avec régulateur et détendeur de pression	154,35 €
---------------	---	----------



<b>AIPP100</b>	Pistolet pulvérisateur 1 L	33,60 €
----------------	----------------------------	---------



<b>AIPB1</b>	Pistolet pour bidon de 1 L insonore corps creux	40,30 €
--------------	--	---------

<b>AIPBIF</b>	Flexible de rechange pour corps creux	16,25 €
---------------	---------------------------------------	---------



<b>AILB/PG</b>	Pistolet de gravage de verre	303,85 €
----------------	------------------------------	----------

<b>AILB/SG</b>	Pot de 1 Kg de sable C4 pour verre	17,55 €
----------------	------------------------------------	---------



<b>AIR1822Z</b>	Pistolet de gonflage EURODAIR	83,25 €
-----------------	-------------------------------	---------

<b>A139064.00</b>	Flexible de rechange	39,15 €
-------------------	----------------------	---------

<b>AIR0985.3</b>	Embout de gonflage	7,55 €
------------------	--------------------	--------



<b>AIASPIJET</b>	Brosse d'aspiration soufflante	79,50 €
------------------	--------------------------------	---------

ASPIJET



## ELEMENTS DE FILTRATION



**AIFRL14**      Filtre régulateur lubrificateur F1/4      99,65 €

**AIFR17**      Filtre régulateur F3/8      114,95 €

**AIL17**      Lubrificateur standard F3/8      68,75 €

**AIFRL17**      Filtre régulateur lubrificateur F3/8      161,40 €

**AIFRL1/2**      Filtre régulateur lubrificateur F1/2      161,40 €

## TRAITEMENT D'AIR COMPLET POUR CABINE DE PEINTURE



**AIFRS1**      Élément submicronique F1/2      475,85 €

## HUILE POUR OUTIL PNEUMATIQUE



**AIHUILEARU**      Burette 100 ml d'huile réseau d'air      2,75 €

**AIHUILEAR**      10 burettes d'huile réseau d'air      23,75 €

**AIHNM**      Burette 100ml spéciale nettoyage  
moteur pneumatique      5,35 €

**AIHUILEAR1L**      Bidon 1L d'huile vaseline      22,25 €

**AIHUILEAR5L**      Bidon 5L d'huile réseau d'air      61,30 €

## ENROULEURS ET RALLONGES D'AIR



**AIEM812**      Enrouleur mural 12m tuyau int.8mm      170,30 €

**AIEM815**      Enrouleur mural 15m tuyau int.8mm      207,90 €

**AIEM1015**      Enrouleur mural 15m tuyau int.10mm      238,25 €

**AIR108**      Rallonge de 10 m équipée 8 x 13mm      41,15 €

**AIR1010**      Rallonge de 10 m équipée 10 x 15mm      53,00 €

## TUYAUX



TUYAU POUR ATELIERS		
AIT814.25	25m tuyau souple PVC renforcé 8x14,5mm	86,30 €
AIT814.50	50m tuyau souple PVC renforcé 8x14,5mm	172,60 €

disponible dans d'autres diamètres sur demande

TUYAU ANTISTATIQUE POUR CABINE DE PEINTURE		
AITA815.20	20m tuyau souple renforcé 8x15mm	68,35 €
AITA1018.20	20m tuyau souple renforcé 10x18mm	90,50 €

disponible en couronne de 40m et dans d'autres diamètres sur demande

## RACCORDS ET COUPLEURS



COUPLEURS PROFIL ISO 6150 B-12 US-MIL 5.5mm		
AIRRF14	Coupleur sécurité F 1/4	15,45 €
AIRRF14	Coupleur standard F 1/4	8,70 €

RACCORDS MACHINE MALE/FEMELLE PROFIL ISO 6150 B-12 US-MIL 5.5mm		
AIEFR14	Embout F1/4 conique pour coupleur	1,90 €
AIEMR14	Embout M1/4 conique pour coupleur	2,10 €

EMBOUS DE RACCORDEMENT PROFIL ISO 6150 B-12 US-MIL 5.5mm		
AIEMRC	Embout cannelé 8mm pour coupleur	2,00 €
AIEMRC10	Embout cannelé 10mm pour coupleur	2,40 €

EMBOUS MALES CANNELES		
AIEM14C8	Embout M1/4 conique cannelé 8mm	1,55 €
AIEM14C10	Embout M1/4 conique cannelé 10mm	1,70 €

MAMELON MALE/MALE CONIQUE		
AIM14	Mamelon M/M 1/4	1,45 €
AIFF14	Jonction F/F 1/4	1,80 €

REDUCTION MALE CONIQUE / FEMELLE		
AIMRM12F38	Mamelon réducteur M 1/2 - F 3/8	2,30 €
AIMRM12F14	Mamelon réducteur M 1/2 - F 1/4	2,60 €
AIMRM38F1/4	Mamelon réducteur M 3/8 - F 1/4	1,55 €

Y DE DERIVATION		
AIRYF1/4	Raccord en Y F 1/4	6,10 €
AIRYF3/8	Raccord en Y F 3/8	9,05 €

## ACCESSOIRES ET COLLIERES 2 OREILLES



AI10041.10	10 colliers 2 oreilles 13-15mm	4,10 €
AI10041.100	100 colliers 2 oreilles 13-15mm	30,45 €
AI10042.10	10 colliers 2 oreilles 15-18mm	5,45 €
AI10042.100	100 colliers 2 oreilles 15-18mm	40,10 €

\* voir grille remises quantitatives

ACCESSOIRES POUR MACHINE PNEUMATIQUE		
AIH24	Mini huileur F1/4 - M1/4	16,40 €
AIRP146	Mini limiteur de pression 6 bars	23,10 €



***MATERIELS ET CONSOMMABLES  
DE SOUDAGE ET DEBOSELAGE***



***OUTILLAGE A MAIN***



## DEBOSSELEUR AIRPULLER



**AIROUTIL**



<b>AIAP95</b>	Débosseleur AIRPULLER en coffret livré avec 5 électrodes et lime diamant	<b>1 199,10 €</b>
---------------	--	-------------------

<b>AITR95</b>	Transformateur spécifique 380V seul	<b>1 114,05 €</b>
---------------	-------------------------------------	-------------------

<b>AIAPTR95</b>	Débosseleur AIRPULLER en coffret livré avec 5 électrodes et lime diamant avec transfo spécifique 380V monophasé	<b>2 212,35 €</b>
-----------------	---	-------------------

<b>AICR70</b>	Chariot pour AIRPULLER ou Minispotter	<b>138,60 €</b>
---------------	---------------------------------------	-----------------

<b>AIAPTRC</b>	Débosseleur AIRPULLER en coffret livré avec 5 électrodes et lime diamant, transfo spécifique 380V monophasé, chariot et masse magnétique	<b>2 336,25 €</b>
----------------	--	-------------------

## ACCESSOIRES POUR AIRPULLER



<b>AI351080</b>	Masse à inertie pour transfo AIRPULLER permet de faire du débosselage par soudage d'étoile ou fil ondulé livrée sans transfo	<b>399,00 €</b>
-----------------	---	-----------------

<b>AI39466</b>	Levier BIPULLER pour fil ondulé	<b>354,90 €</b>
----------------	---------------------------------	-----------------

<b>AI351060</b>	Levier MAXILIFT pour fil ondulé avec triple griffe	<b>313,95 €</b>
-----------------	--	-----------------

<b>AI358050</b>	Triple griffe pour levier MAXILIFT	<b>138,05 €</b>
-----------------	------------------------------------	-----------------

<b>AI351050</b>	Levier MAXILIFT avec support pour électrode Powerlift	<b>324,45 €</b>
-----------------	---	-----------------

<b>AI358060</b>	Support électrode POWERLIFT	<b>163,80 €</b>
-----------------	-----------------------------	-----------------

<b>AI39489</b>	Masse magnétique	<b>72,35 €</b>
----------------	------------------	----------------

<b>AI39524</b>	Mini masse à souder	<b>40,00 €</b>
----------------	---------------------	----------------

<b>AI524001</b>	1 électrode pour masse à souder	<b>17,65 €</b>
-----------------	---------------------------------	----------------



## CONSOMMABLES POUR AIRPULLER



**AIROUTIL**



<b>AI357000</b>	5 électrodes de soudage	<b>55,45 €</b>
<b>AI357001</b>	1 électrode de rétreint	<b>16,40 €</b>
<b>AI357002</b>	6 électrodes dont 1 de rétreint	<b>66,90 €</b>

<b>AI357022</b>	4 électrodes POWERLIFT	<b>66,15 €</b>
-----------------	------------------------	----------------

<b>AI358118</b>	Lime diamant pour électrode	<b>66,15 €</b>
-----------------	-----------------------------	----------------

<b>AI507031</b>	50 fils ondulés à souder	<b>51,45 €</b>
-----------------	--------------------------	----------------

<b>AI507035</b>	1 électrode spéciale fil ondulé	<b>38,45 €</b>
-----------------	---------------------------------	----------------

## SPOTTERS



<b>AI39513</b>	Mini spotter 230V 2500w complet	<b>1 543,50 €</b>
----------------	---------------------------------	-------------------

<b>AI39539</b>	Masse à inertie pour spotter avec mandrin porte étoile	<b>141,95 €</b>
----------------	--	-----------------



<b>AI39123</b>	Coffret pistolet à souder 230V	<b>643,10 €</b>
----------------	--------------------------------	-----------------



<b>AI39518</b>	Coffret pistolet à souder 230V avec fils ondulés et griffe	<b>706,95 €</b>
----------------	--	-----------------

## CONSOMMABLES POUR SPOTTERS ET PISTOLETS A SOUDER



<b>AICS2050</b>	Bte 500 clous à souder 2x50mm	<b>16,60 €</b>
<b>AICS2550</b>	Bte 500 clous à souder 2,5x50mm	<b>23,10 €</b>
<b>AIRS16</b>	Bte 100 rondelles à souder	<b>13,65 €</b>

<b>AI501031</b>	Mandrin M10 porte étoile à souder	<b>52,80 €</b>
-----------------	-----------------------------------	----------------

<b>AI501033</b>	Mandrin M14 porte étoile à souder	<b>52,80 €</b>
-----------------	-----------------------------------	----------------

<b>AI297013</b>	Sachet 15 étoiles à souder	<b>15,10 €</b>
-----------------	----------------------------	----------------

<b>AI51300018</b>	Sachet 150 étoiles à souder	<b>127,55 €</b>
-------------------	-----------------------------	-----------------



## FASTIN ET ETAIN EN BAGUETTE A 33%



<b>AIEB332</b>	2 Kgs de soudure d'étain 33%	*	<b>50,10 €</b>
<b>AIEB335</b>	5 Kgs de soudure d'étain 33%	*	<b>123,25 €</b>
<b>AIEB3310</b>	10 Kgs de soudure d'étain 33%	*	<b>245,50 €</b>

\* Prix indicatif au 01/01/2016 (variable suivant le cours des métaux précieux)

<b>AIPF500</b>	Pot 500gr pâte à étamer FASTIN	<b>23,85 €</b>
----------------	--------------------------------	----------------

## DEBOSELAGE PAR COLLAGE

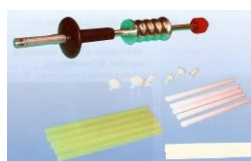

<b>AI39546</b>	Coffret de débosselage par collage	<b>348,50 €</b>
<b>AI39563</b>	Kit débosselage à inertie	<b>177,45 €</b>
<b>AIPBC</b>	Pistolet pour bâton de colle	<b>12,60 €</b>

CONSOMMABLES pour DEBOSELAGE par COLLAGE		
<b>AI546009</b>	10 bâtons colle blanche	<b>13,65 €</b>
<b>AI546010</b>	10 bâtons colle ambre	<b>13,65 €</b>
<b>AIAWSCOL</b>	10 bâtons colle rouge	<b>25,20 €</b>
<b>AI546007</b>	6 embouts de tirage divers diamètres	<b>25,95 €</b>
<b>AI546007P</b>	6 petits embouts de tirage divers diamètres	<b>25,95 €</b>
<b>AI546007M</b>	6 moyens embouts de tirage divers diam.	<b>25,95 €</b>
<b>AI546007G</b>	6 gros embouts de tirage divers diamètres	<b>25,95 €</b>

## CONSOMMABLES POUR DEBOSELAGE PAR COLLAGE



<b>AI387000</b>	5 têtes panachées pour DS20	<b>91,85 €</b>
<b>AI388001</b>	Jet téflon	<b>15,75 €</b>
<b>AI388002</b>	Spatule plastique pour colle	<b>4,70 €</b>
<b>AI388020</b>	Flacon éliminateur de colle	<b>36,20 €</b>
<b>AI388021</b>	Flacon de dégraissant	<b>24,90 €</b>

## CONSOMMABLES DE SOUDAGE POUR POINTEUSE



<b>AI497001</b>	6 caps bombés ronds 13mm	<b>46,60 €</b>
<b>AI497005</b>	6 caps plats ronds 13mm	<b>48,20 €</b>
<b>AI297121</b>	6 caps bombés ronds 12mm	<b>57,75 €</b>

<b>AI498003</b>	Clé tire caps	<b>104,70 €</b>
-----------------	---------------	-----------------



<b>AI297107</b>	Crayon à rétreint 10mm	<b>9,45 €</b>
<b>AI497026</b>	Crayon à rétreint 12mm	<b>24,65 €</b>



<b>AI497010</b>	Tube 100gr pâte cuivre pour caps	<b>36,20 €</b>
-----------------	----------------------------------	----------------



<b>AI297300</b>	100 plaquettes test de soudage V2A	<b>55,65 €</b>
-----------------	------------------------------------	----------------

## SOUDEGE DES PLASTIQUES



<b>AI39644</b>	Mini soudeur plastique à gaz	<b>127,05 €</b>
----------------	------------------------------	-----------------

<b>AI39644001</b>	Cartouche de gaz	<b>6,30 €</b>
<b>AI39644005</b>	5 cartouches de gaz	<b>28,35 €</b>



<b>AI39663</b>	Soudeur d'agrafes pour la réparation de pièce en plastique, polypro et PVC fourni avec composition de 300 agrafes sur 4 modèles ci-dessous	<b>501,90 €</b>
----------------	--	-----------------

<b>AI39663S001</b>	100 agrafes lacets autocassantes	1	<b>51,05 €</b>
<b>AI39663S002</b>	100 agrafes grecquées autocassantes	2	<b>37,15 €</b>
<b>AI39663S003</b>	100 agrafes d'angle int. autocassantes	3	<b>37,15 €</b>
<b>AI39663005</b>	100 agrafes d'angle ext.	4	<b>29,00 €</b>

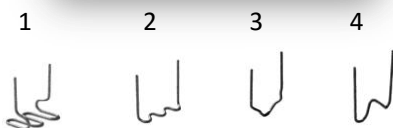

<b>AICRP</b>	Coffret de réparation des pattes en plastique/pvc/polypro. Avec 3 cartouches	<b>185,65 €</b>
--------------	--	-----------------



<b>AICRP1</b>	Pistolet pour cartouche 50ml bi-comp.	<b>24,15 €</b>
---------------	---------------------------------------	----------------

<b>AICRP2</b>	Lot 6 cartouches 50ml SUPERFAST <b>séchage en 1 minute</b>	<b>137,85 €</b>
<b>AICRP5</b>	Aérosol 200ml primaire d'accroche	<b>15,55 €</b>
<b>AICRP4</b>	Rx film de mise en forme	<b>20,60 €</b>
<b>AICRP3</b>	Lot 50 buses mélangeuses	<b>47,75 €</b>

## VENTOUSES DE MAINTIEN ET DE REDRESSAGE



<b>AI39601</b>	Mini super ventouse 30kgs/75mm	*	<b>15,75 €</b>
----------------	--------------------------------	---	----------------

\* Voir grille remises quantitatives

<b>AI39602</b>	Ventouse de tirage 50Kgs/125mm	<b>71,70 €</b>
----------------	--------------------------------	----------------



<b>AI39571</b>	Ventouse à pompe 80Kgs/180mm	<b>153,00 €</b>
----------------	------------------------------	-----------------



<b>AI39171</b>	kit ventouses pour pare-brise	<b>118,10 €</b>
----------------	-------------------------------	-----------------

# ACCESSOIRES DE SOUDAGE



**AIROUTIL**<sup>®</sup>



**AITM3** Torche de mig 3m type MB15 **92,90 €**



**AIBC** 5 buses coniques **13,65 €**

<b>AITC06</b>	10 tubes contact 0,6mm	<b>14,70 €</b>
<b>AITC08</b>	10 tubes contact 0,8mm	<b>14,70 €</b>



**AISTM** Support de torche magnétique **13,85 €**

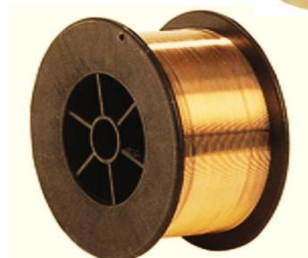

**AIBF08** Bobine 15Kgs fil mig G3Si1 0,8mm **70,35 €**



- > Couleur : *gris souris*
- > Enduction : *2 faces*
- > Poids au m<sup>2</sup> : *1130 g*
- > Classement feu : *M0 à 900° C*

**AICPS2** Couverture de protection soudage 2x2m **207,90 €**  
existe dans d'autres dimensions sur demande



**AIMIGALE** Cagoule de soudage teinte variable 9-13  
Cellule garantie 2 ans **103,95 €**

# MATERIELS POUR ATELIER CARROSSERIE



# AIROUTIL®



**AI39425** Tréteau JUMBO 138,90 €

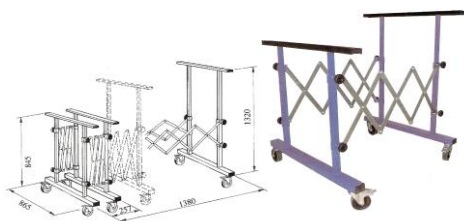

**AI39570R** Tréteau extensible multi-positions 411,60 €



**AI39606** Chariot porte pare choc 275,10 €

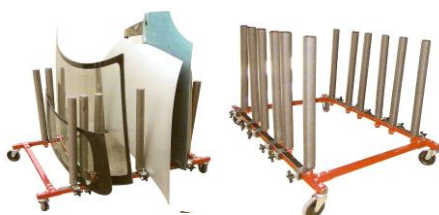

**AI39641** Support d'éléments réglable 289,50 €



**AI39628F** chariot pour pièces carrosserie 535,50 €



## MATERIELS POUR ATELIER CARROSSERIE



# AIROUTIL®



**AI39465**

Levier d'ajustement de portière

**81,90 €**



**AI39534B**

Marchepied en ALU  
Hauteur 0,320 M / Longueur 1 M

**154,35 €**

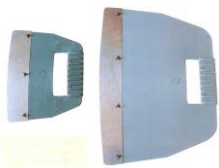

**AI39604**

Jeu de 2 protecteurs de tableau de bord  
modèle renforcé

**92,60 €**



**AI39643**

Génératrice d'air chaud pour séchage  
des peintures à l'eau 150m<sup>3</sup>/h à 70°

**1 183,35 €**

**AI39643CP**

Générateur d'air chaud pour cabine de  
peinture 230V 1750w  
température de sortie 60 à 70° réglable  
3,5m de longueur de tuyau en sortie  
de cabine

**1 399,10 €**



**AI39643002**

Rallonge 3,3m tuyau flexible

**140,70 €**

**PINCES DE TIRAGE**



**AIA11**

Pince fine droite largeur 42mm

**220,50 €**

# OUTILLAGE A MAIN

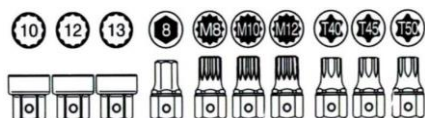

<b>KO1210E</b>	Levier à cliquet de démontage . des charnières de portes + 10 embouts	<b>140,60 €</b>
<b>KO179B12HD10</b>	Douille 10 mm	<b>11,85 €</b>
<b>KO179B12HD12</b>	Douille 12 mm	<b>11,85 €</b>
<b>KO179B12HD13</b>	Douille 13 mm	<b>12,90 €</b>
<b>KO179B12HH8</b>	Douille hexagonale 8 mm	<b>9,85 €</b>
<b>KO179B12HXZN8</b>	Douille XZN M8	<b>9,85 €</b>
<b>KO179B12HXZN10</b>	Douille XZN M10	<b>9,85 €</b>
<b>KO179B12HXZN12</b>	Douille XZN M12	<b>9,85 €</b>
<b>KO179B12HT40</b>	Douille TORX 40	<b>9,85 €</b>
<b>KO179B12HT45</b>	Douille TORX 45	<b>9,85 €</b>
<b>KO179B12HT50</b>	Douille TORX 50	<b>9,85 €</b>



<b>KO1212</b>	Lot de 4 tournevis 250 mm serrures de portières	<b>78,45 €</b>
<b>KO168TT20</b>	Tournevis TORX 20 long. 250mm	<b>18,25 €</b>
<b>KO168TT25</b>	Tournevis TORX 25 long. 250mm	<b>18,70 €</b>
<b>KO168TT30</b>	Tournevis TORX 30 long. 250mm	<b>19,40 €</b>
<b>KO168T20PR</b>	Tournevis Penta-lobe (PR) long. 250mm	<b>22,05 €</b>



<b>KO169WM</b>	Levier de démontage des joints de vitre	<b>38,85 €</b>
----------------	---	----------------



<b>KO169.6</b>	Levier de dégarnissage 6 mm	<b>18,35 €</b>
<b>KO169.10</b>	Levier de dégarnissage 10 mm	<b>19,65 €</b>



<b>KO2769H</b>	Poignée articulée Lg.160 mm 1/4"	<b>41,70 €</b>
----------------	----------------------------------	----------------

<b>KO3769H</b>	Poignée articulée Lg.160 mm 3/8"	<b>42,65 €</b>
----------------	----------------------------------	----------------



<b>KO4788/300</b>	Poignée 1/2" force Lg. 300 mm	<b>21,85 €</b>
-------------------	-------------------------------	----------------

<b>KO4747</b>	Poignée 1/2" double carré Lg. 250mm	<b>21,00 €</b>
---------------	-------------------------------------	----------------



<b>KO4760.400</b>	Rallonge 1/2" extra longue 400 mm	<b>30,75 €</b>
-------------------	-----------------------------------	----------------

<b>KO4760.600</b>	Rallonge 1/2" extra longue 600 mm	<b>46,50 €</b>
-------------------	-----------------------------------	----------------

<b>KO4760.1000</b>	Rallonge 1/2" extra longue 1000 mm	<b>91,85 €</b>
--------------------	------------------------------------	----------------



<b>KO2120</b>	Adaptateur magnétique 1/4"	<b>11,95 €</b>
---------------	----------------------------	----------------



<b>KO2762</b>	Rallonge flexible Lg. 300 mm F1/4 " M1/4"	<b>27,20 €</b>
---------------	---	----------------



<b>KO3762</b>	Rallonge flexible Lg. 300 mm F3/8" M3/8"	<b>34,10 €</b>
---------------	--	----------------



<b>AI39345A</b>	Rallonge angulaire 1/2	<b>17,55 €</b>
-----------------	------------------------	----------------

<b>AI39345B</b>	Rallonge angulaire 3/8	<b>14,60 €</b>
-----------------	------------------------	----------------

## BOUGIE ESSENCE/PRECHAUFFAGE

### ACCESSOIRES 3/8" POUR BOUGIE

KO3751J	Cliquet 3/8" dynamométrique pré réglé à 25 N.m	98,50 €
KO3701/20	Douille 3/8" dynamométrique pré réglée à 20 N.m	79,70 €
KO3701/30	Douille 3/8" dynamométrique pré réglée à 20 N.m	79,70 €
KO3763/75	Allonge angulaire Lg.75	11,55 €
KO3763/125	Allonge angulaire Lg.125	13,45 €
KO3715SL	Clé Té coulissante	28,05 €

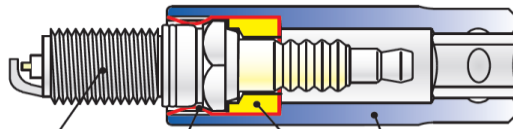
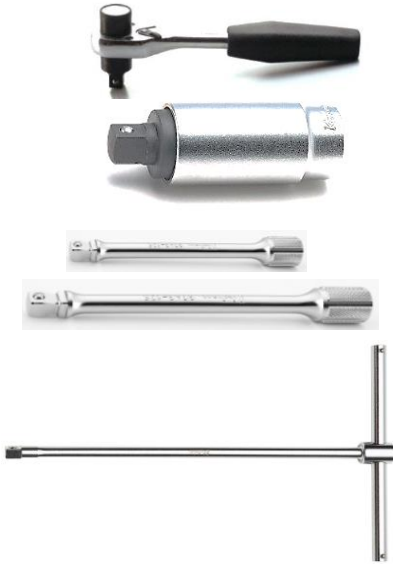

Bougie Ressort de maintien Laiton Corps de douille

### DOUILLES 3/8" POUR BOUGIE ESSENCE

	KO3300C13	13 mm	6 pans	21,20 €
	KO3300C14	14 mm	6 pans	21,20 €
	KO3300C16	16 mm	6 pans	21,20 €
	KO3300C18	18 mm	6 pans	21,40 €
	KO3300C20,8	20,8 mm	6 pans	25,10 €
	KO3340C14	14 mm	6 pans articulée	42,85 €
	KO3340C16	16 mm	6 pans articulée	46,85 €
	KO3340C20,8	20,8 mm	6 pans articulée	56,20 €
	KO3300C250-14	14 mm	6 pans Lg. 250mm	39,15 €
	KO3300C250-16	16 mm	6 pans Lg. 250mm	39,90 €
	KO3300C250-20,8	20,8 mm	6 pans Lg. 250mm	53,75 €
	KO3305P14	14 mm	12 pans	23,95 €
	KO3300CB	16 mm	6 pans BMW	33,60 €

### DOUILLES 3/8" ARTICULEES POUR BOUGIE PRECHAUFFAGE DIESEL

	KO3341G-70-10	10 mm	BOUGIE STANDARD	36,95 €
	KO3341G-70-11	11 mm	BOUGIE STANDARD	36,95 €
	KO3341G-70-12	12 mm	BOUGIE STANDARD	36,95 €
	KO3341G-89-8	8 mm	BOUGIE CRAYON	38,55 €
	KO3341G-89-9	9 mm	BOUGIE CRAYON	38,55 €
	KO3341G-89-10	10 mm	BOUGIE CRAYON	38,55 €



## DOUILLES AVEC BILLE DE RETENUE



**AIROUTIL**<sup>®</sup>

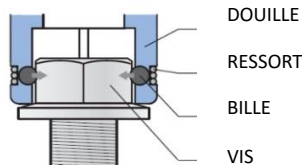

**KORS2450MS/6** Jeu de 6 douilles sécurité 1/4" sur rail  
7,8,10,12,13,14 \* **45,65 €**



**KORS3450M/8** Jeu de 8 douilles sécurité 3/8" sur rail  
8,10,11,12,13,14,17,19 \* **61,30 €**



**KORS4450M/10** Jeu de 10 douilles sécurité 1/2" sur rail  
10,11,12,13,14,15,17,19,21,22 \* **84,00 €**

## REGLETTE DE DOUILLES FEMELLES TORX

**KORSX425/14** Réglette 14 douilles femelles Torx de E4 à E24 \* **65,40 €**



1/4"	E4, E5, E6, E7, E8
3/8"	E10, E11, E12, E14
1/2"	E16, E18, E20, E22, E24

## REGLETTE DE DOUILLES 12 PANS

**KORS2405M/11** Réglette 11 douilles 12 pans courtes 1/4"  
4,5,6,7,8,9,10,11,12,13,14 mm \* **33,50 €**



**KORS2305M/11** Réglette 11 douilles 12 pans longues 1/4"  
4,5,6,7,8,9,10,11,12,13,14 mm \* **68,55 €**

**KORS3405M/12** Réglette 12 douilles 12 pans courtes 3/8"  
8,9,10,11,12,13,14,15,16,17,18,19 mm \* **49,05 €**

**KORS3305M/12** Réglette 12 douilles 12 pans longues 3/8"  
8,9,10,11,12,13,14,15,16,17,18,19 mm \* **99,10 €**



**KORS4406M/10** Réglette 10 douilles 12 pans courtes 1/2"  
10,11,12,13,14,15,16,17,18,19 mm \* **50,10 €**

**KORS4305M/10** Réglette 10 douilles 12 pans longues 1/2"  
10,11,12,13,14,15,16,17,18,19 mm \* **115,70 €**

\* D'autres dimensions sont disponibles au détail sur commande.

**CLIQUET / COFFRET**



<b>KO2753PS</b>	MICRO-CLIQUET 1/4" Lg. 75mm	<b>37,60 €</b>
<b>KO2749PS</b>	MICRO-CLIQUET 3/8" Lg. 75mm	<b>46,85 €</b>
<b>KO3749SB</b>	MICRO-CLIQUET 1/2"	<b>49,25 €</b>



<b>AI39350</b>	coffret de douilles traversantes avec rallonge, réducteur mâle 1/4 - 3/8 et douilles de 8 à 19mm	<b>93,05 €</b>
----------------	--	----------------



- 2233A (1/4") x 3/8"
- 3322A (3/8") x 1/4"
- 3344A (3/8") x 1/2"
- 4433A (1/2") x 3/8"
- 4466A (1/2") x 3/4"
- 6644A (3/4") x 1/2"

<b>KOPK2346/6</b>	Module de 6 adaptateurs	<b>73,70 €</b>
-------------------	-------------------------	----------------



<b>KO4202</b>	Coffret 1/2" embouts de vidange 7 pièces 11 empreintes	<b>60,35 €</b>
---------------	--	----------------

## OUTILLAGES DIVERS



ASSISTANCE  
MATERIEL  
OUTILLAGE

**AIROUTIL**<sup>®</sup>



**AI581101** Coin à dégarnir fin 22,90 €

**AI581102** Coin à dégarnir épais 33,05 €



**AI581104** Coin à dégarnir pour agrafes 22,90 €



**AI39193N** Pince à dégarnir 29,30 €



**AI39607** Jeu 2 pinces GRIPP-AUTO 16,25 €



**AI39620** Jeu 3 burins carrossier 65,50 €



**AI39603** Jeu 4 burins NYLON 25,40 €



**AI39578** Cuve de nettoyage couteau à mastic 29,20 €

**AI578001** Lot 3 garnitures de grattage 15,10 €



**AI39515N** Kit cutter PRO 38,45 €

**AI395151** Jeu 10 lames 12mm 13,55 €

**AI395152** Jeu 10 lames 16mm 13,55 €

**AI395153** Jeu 10 lames 20mm 13,55 €

**AI395155** Jeu 10 lames 16mm inclinées 13,55 €



**AI39615** Rx 1,35m x 30mm de bande magnétique pour maintien du film à cabine de peinture 14,60 €

## CONSOMMABLE CARROSSERIE

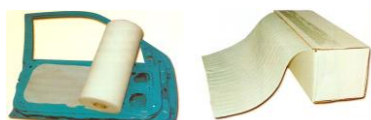

**AI39520B** Rx 10m x 0,65m mousse adhésive blanche pour intérieur de porte 74,25 €

## LUSTRAGE A LA MAIN



ASSISTANCE  
MATÉRIEL  
OUTILLAGE

**AIROUTIL**



<b>AIBX711U4</b>	Pack 6 bonnettes à lustrer dont 1 face à démoussifier	<b>22,55 €</b>
------------------	--	----------------

## MATERIELS D'ENTRETIEN POUR VEHICULES



<b>AIBX342U4</b>	Brosse pour jante PM 60x120mm *	<b>7,65 €</b>
------------------	---------------------------------	---------------



<b>AIBX349U4</b>	Brosse pour jante GM 90x200mm *	<b>12,70 €</b>
------------------	---------------------------------	----------------



<b>AIBX496U4</b>	Raclette PRO silicone 30cms *	<b>18,15 €</b>
------------------	-------------------------------	----------------



<b>AIGLM</b>	Gant de lavage mouton *	<b>21,00 €</b>
--------------	-------------------------	----------------

<b>AIX155U4</b>	Mouffle de lavage PRO.	<b>14,40 €</b>
-----------------	------------------------	----------------

<b>AIBX160C51U4</b>	Gant de lavage microfibre *	<b>12,70 €</b>
---------------------	-----------------------------	----------------



<b>AIX256</b>	Nénette PRO. XXL *	<b>12,90 €</b>
---------------	--------------------	----------------

<b>AIX260U4</b>	Nénette XXL repliable *	<b>12,50 €</b>
-----------------	-------------------------	----------------



<b>AIX279U4</b>	Recharge nénétoil *	<b>7,75 €</b>
-----------------	---------------------	---------------

\* voir grille remises quantitatives

## OUTILLAGE ATELIER MECANIQUE

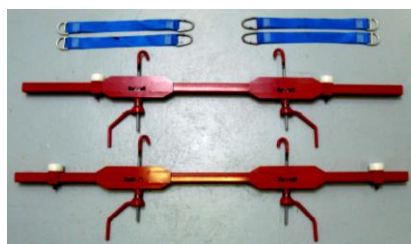

<b>AIBC400</b>	Kit de compression de caisse V.L.	<b>1 039,50 €</b>
----------------	-----------------------------------	-------------------





## DONNEES TECHNIQUES

### COUPE-GOMMES

	Nb d'oscillations	Poids	Consommation	Puissance	Niveau vibrations	Niveau sonore
AICG187	0 à 13200/mn	0,800 kg	350 l/mn	360 W	2 en X/6,8 en Y/3,6 en	99 dB(A)
AICG6	20000/mn	1,000 kg	140 l/mn	450 W	3,5 m/s <sup>2</sup>	80 dB(A)

### SCIES ALTERNATIVES

	Vitesse	Poids	Consommation	Puissance	Niveau vibrations	Niveau sonore
AISA186	9000 coups/mn	0,480 kg	280 l/mn		27,11 m/s <sup>2</sup>	88 dB(A)
AISA1	10000 coups/mn	0,700 kg	150 l/mn		25 m/s <sup>2</sup>	73 dB(A)

### PONCEUSES

	Vitesse	Poids	Consommation	Puissance	Niveau vibrations	Niveau sonore
AIPA97	9500 tr/mn	1,100 kg	280 l/mn		4,4 m/s <sup>2</sup>	78 dB(A)
AIPE1A	10000 tr/mn	0,900 kg	240 l/mn		3 m/s <sup>2</sup>	75 dB(A)
AIPE2C	10000 tr/mn	0,950 kg	400 l/mn	175 W	2,5 m/s <sup>2</sup>	75 dB(A)
AIPE3CA	10000 tr/mn	1,340 kg	300 l/mn		3 m/s <sup>2</sup>	75 dB(A)
AIPO12	9000 tr/mn	1,670 kg	400 l/mn	600 W	4 m/s <sup>2</sup>	85 dB(A)
AIPV96	8000 tr/mn	1,100 kg	180 l/mn		2,74 m/s <sup>2</sup>	78 dB(A)

### SURFACEURS

	Vitesse	Poids	Consommation	Puissance	Niveau vibrations	Niveau sonore
AISU150	1000 tr/mn	1,500 kg	350 l/mn		2,5 m/s <sup>2</sup>	
AISU150A	900 tr/mn	2,300 kgs	450 l/mn	700 W	5 m/s <sup>2</sup>	85 dB(A)
AISU203E	900 tr/mn	2,200 kgs	350 l/mn		2,5 m/s <sup>2</sup>	
AISU203A	900 tr/mn	2,300 kgs	450 l/mn	700 W	5 m/s <sup>2</sup>	85 dB(A)

### PONCEUSES A BANDE

	Vitesse	Poids	Consommation	Puissance	Niveau vibrations	Niveau sonore
AIPB573	16000 tr/mn	0,750 kg	390 l/mn	270 W	< 2,5 m/s <sup>2</sup>	85 dB(A)
AIPB52	16000 tr/mn	1,400 kg	400 l/mn	450 W	< 2,5 m/s <sup>2</sup>	85 dB(A)

### PONCEUSES 75mm

	Vitesse	Poids	Consommation	Puissance	Niveau vibrations	Niveau sonore
AIPE5C	11000 tr/mn	0,600 kg	240 l/mn	175 W	0,8 m/s <sup>2</sup>	80 dB(A)
AIPO75	15000 tr/mn	0,750 kg	170 l/mn	150 W	< 2,5 m/s <sup>2</sup>	90 dB(A)

### LUSTREUSES

	Vitesse	Poids	Consommation	Puissance	Niveau vibrations	Niveau sonore
AILR75	2500 tr/mn	0,900 kg	170 l/mn	200 W	< 2,5 m/s <sup>2</sup>	85 dB(A)
AILV18C	1800 tr/mn	1,240 kg	250 l/mn	275 W	< 2,5 m/s <sup>2</sup>	82 dB(A)
AILR50C	2500 tr/mn	2,000 kgs	250 l/mn	500 W	< 2,5 m/s <sup>2</sup>	85 dB(A)
AILV51C	2000 tr/mn	2,400 kgs	280 l/mn	510 W	< 2,5 m/s <sup>2</sup>	88 dB(A)

### BROSSEUSES

	Vitesse	Poids	Consommation	Puissance	Niveau vibrations	Niveau sonore
AIBT38C	3500 tr/mn	1,250 kg	160 l/mn	550 W	< 3,5 m/s <sup>2</sup>	83 dB(A)
AIBT3C	3500 tr/mn	1,250 kg	160 l/mn	550 W	< 3,5 m/s <sup>2</sup>	83 dB(A)

### SERTISSEUSE

	CADENCE	Poids	Consommation	Niveau vibrations	Niveau sonore
AISPPBA	2100 C/min	1,800 kg	280 l/mn	4,5 m/s <sup>2</sup>	90 dB(A)

**MEULEUSES**

	Vitesse	Poids	Consommation	Puissance	Niveau vibrations	Niveau sonore
AIM22	22000 tr/mn	0,550 kg	160 l/mn	420 W	< 2,5 m/s <sup>2</sup>	90 dB(A)
AIM22C	22000 tr/mn	0,600 kg	160 l/mn	430 W	< 2,5 m/s <sup>2</sup>	80 dB(A)
AIM45 (V)	4500 tr/mn	0,800 kg	160 l/mn	420 W	< 2,5 m/s <sup>2</sup>	90 dB(A)
AIM9	22000 tr/mn	0,470 kg	160 l/mn	225 W	< 2,5 m/s <sup>2</sup>	85 dB(A)
AIDR491	22000 tr/mn	0,490 kg	300 l/mn	225 W	< 2,5 m/s <sup>2</sup>	85 dB(A)
AI39529	18000 tr/mn	0,900 kg	160 l/mn	300 W	< 2,5 m/s <sup>2</sup>	85 dB(A)

**PERCEUSES**

	Vitesse	Poids	Consommation	Puissance	Niveau vibrations	Niveau sonore
AIMFA10C	2600 tr/mn	0,950 kg	300 l/mn	370 W	< 2,5 m/s <sup>2</sup>	85 dB(A)
AIMF3C	800 tr/mn	1,500 kg	160 l/mn	380 W	< 2,5 m/s <sup>2</sup>	85 dB(A)
AIMF4	1200 tr/mn	1,100 kg	140 l/mn	180 W	< 2,5 m/s <sup>2</sup>	80 dB(A)
AIMF5C	0-2500 tr/mn	1,000 kg	720 l/mn	450 W	< 2,5 m/s <sup>2</sup>	80 dB(A)

**DISQUEUSES**

	Vitesse	Poids	Consommation	Puissance	Niveau vibrations	Niveau sonore
AIDRA18B	18000 tr/mn	1,050 kg	300 l/mn	450 W	< 2,5 m/s <sup>2</sup>	85 dB(A)
AIDRA19C	14000 tr/mn	1,400 kg	180 l/mn	550 W	< 2,5 m/s <sup>2</sup>	80 dB(A)
AIDR20	4500 tr/mn	2,000 kgs	250 l/mn	500 W	< 2,5 m/s <sup>2</sup>	85 dB(A)
AIDV21	4000 tr/mn	2,400 kgs	250 l/mn	475 W	< 2,5 m/s <sup>2</sup>	85 dB(A)

**BURINEUR/GRATTOIR/DECAPEUR**

	Cadence	Poids	Consommation	Niveau vibrations	Niveau sonore
AIBC10C	3000 C/min	1,500kg	270 l/mn	4,5 m/s <sup>2</sup>	90 dB(A)
AIGDC	480 C/min	0,700 kg	250 l/mn	12 m/s <sup>2</sup>	86 dB(A)
AIMA19	2200 C/min	2,500 kgs	285 l/mn	13 m/s <sup>2</sup>	94 dB(A)

**GRIGNOTEUSE/CRAYON A GRAVER**

	Fréquence	Poids	Consommation	Niveau vibrations	Niveau sonore
AIGR12		0,900kg	160 l/mn	< 2,5 m/s <sup>2</sup>	90 dB(A)
AIGR12	500 Hz	0,120 kg	30 l/mn	< 2,5 m/s <sup>2</sup>	85 dB(A)

**RIVETEUSES**

	Force	Poids	Consommation	Niv. vibrations	Niveau sonore
AIRV1	720 kgs	1,500 kg	1,4 l/coup	< 2,5 m/s <sup>2</sup>	50 dB(A)
AIRV2	1080 kgs	2,100 kgs	1,8 l/coup	< 2,5 m/s <sup>2</sup>	50 dB(A)
AIRIV3	1680 kgs	1,930 kg	2,1 l/coup	< 2,5 m/s <sup>2</sup>	50 dB(A)

**MEULEUSE D'ANGLE**

	Vitesse	Poids	Consommation	Puissance	Niveau vibrations	Niveau sonore
AIM125	11000 tr/mn	1,800 kg	300 l/mn	450 W	2,8 m/s <sup>2</sup>	86 dB(A)

**CLES A CLIQUET**

	Vitesse	Poids	Consommation	Couple	Niveau vibrations	Niveau sonore
AICR2C	200 tr/mn	0,500 kg	90 l/mn	30 Nm	3 m/s <sup>2</sup>	75 dB(A)
AI39638	200 tr/mn	0,400 kg	90 l/mn	27 Nm	2,5 m/s <sup>2</sup>	75 dB(A)
AICR6	150 tr/mn	1,150 kg	90 l/mn	60 Nm	3,8 m/s <sup>2</sup>	90 dB(A)
AICR5C	150 tr/mn	1,200 kg	100 l/mn	70 Nm	3 m/s <sup>2</sup>	80 dB(A)
AICR7C	150 tr/mn	1,200 kg	100 l/mn	70 Nm	3 m/s <sup>2</sup>	80 dB(A)

**CLES A CHOCS**

	Vitesse	Poids	Consommation	Couple	Niveau vibrations	Niveau sonore
AICC10	10000 tr/mn	1,000 kg	85 l/mn	100 Nm	2,9 m/s <sup>2</sup>	85 dB(A)
AICLE54B	7000 tr/mn	2,550 kgs	390 l/mn	540 Nm	2,5 m/s <sup>2</sup>	85 dB(A)
AICC9CV	8000 tr/mn	2 kgs	280 l/mn	980Nm	3 m/s <sup>2</sup>	90 dB(A)
AICC16	5000 tr/mn	5,100 kgs	980 l/mn	1630 Nm	3,5 m/s <sup>2</sup>	85 dB(A)
AICC24	3200 tr/mn	9,500 kgs	700 l/mn	22000 Nm	3,5 m/s <sup>2</sup>	85 dB(A)
AICCD24	4100 tr/mn	9,300 kgs	700 l/mn	2300 Nm	4 m/s <sup>2</sup>	85 dB(A)
AICCDL24	4100 tr/mn	9,800 kgs	700 l/mn	2300 Nm	4 m/s <sup>2</sup>	85 dB(A)